



**Marcelo Rafael  
Sousa Manteigas**

**Adaptive Algorithms for Cost-Efficient Pump  
Control in Water Distribution Network**

Algoritmos Adaptativos para Controlo Eficiente de  
Bombas numa Rede de Distribuição de Água





**Marcelo Rafael  
Sousa Manteigas**

**Adaptive Algorithms for Cost-Efficient Pump  
Control in Water Distribution Network**

Algoritmos Adaptativos para Controlo Eficiente de  
Bombas numa Rede de Distribuição de Água

Dissertação apresentada à Universidade de Aveiro para cumprimento dos requisitos necessários à obtenção do grau de Mestre em Engenharia Mecânica, realizada sob a orientação científica de António Gil d'Orey de Andrade Campos, Professor Auxiliar do Departamento de Engenharia Mecânica da Universidade de Aveiro.

Esta dissertação teve o apoio dos projetos UID/EMS/00481/2019-FCT - FCT - Fundação para a Ciência e a Tecnologia; e CENTRO-01-0145-FEDER-022083 - Programa Operacional Regional do Centro (Centro2020), através do Portugal 2020 e do Fundo Europeu de Desenvolvimento Regional.



Dedico este trabalho ao meu querido pai, Carlos Alberto Sá Manteigas, sem o qual esta aventura universitária maravilhosa não teria sido possível.



## **o júri / the jury**

Presidente / president

**Prof. Doutor João Alexandre Dias de Oliveira**  
Professor Auxiliar Departamento de Engenharia Mecânica Universidade de Aveiro

**Doutor Bruno Alexandre Abreu da Silva**  
Director Executivo, Scubic

**Prof. Doutor Gil D'Orey de Andrade Campos**  
Professor Auxiliar Departamento de Engenharia Mecânica Universidade de Aveiro  
(orientador)





## **agradecimentos**

Ao meu pai pelo incansável apoio em todos os meus desafios e conquistas.

Ao meu orientador por inspirar a exigência que uma dissertação merece, e pelas discussões abertas que originaram muitas das ideias aplicadas neste trabalho.

Aos meus grandes amigos, João Veloso, João Marques e Gonçalo Silva, por me acompanharem neste processo assim como em toda a minha aventura universitária.

Aos meus colegas do projecto Learning Experiment, por me motivarem a aprender mais e a continuar curioso.

À minha namorada, Eiko Kosztolanczi, por me incentivar a cumprir as minhas responsabilidades académicas em vez de apreciar um belo jantar de sushi, e uma caminhada à beira mar.

À Universidade de Aveiro por proporcionar um ecossistema rico e dinâmico para aprender e crescer.

Por fim, obrigado a todas as pessoas que fizeram parte do meu caminho e sem as quais não seria o ser humano que sou hoje!



**palavras-chave**

Algoritmos Adaptativos, Estratégia de Bombeamento, Eficiência, Rede de Distribuição de Água, Modelos de Controlo, Controlo Adaptativo.

**resumo**

Cidades modernas têm redes de distribuição de água que de forma confiável satisfazem as necessidades de água de todos os domicílios. Estas redes dependem de bombas para mover a água de fontes distantes ao consumidor. Se gerido de forma ineficiente, este processo consumidor de energia pode tornar-se muito dispendioso. Através de poder computacional emergente, tecnologias de simulação e sensores, muitas técnicas foram desenvolvidas para produzir as melhores estratégias de operação. Estas metodologias dependem de previsões do consumo de água para criar estratégias de bombeamento óptimas. Porém, estas previsões contêm sempre erros, que podem criar problemas de controlo. Muitos esforços foram feitos para desenvolver melhores previsões, algumas das quais podem mudar os seus parâmetros em tempo real. De qualquer forma, estas soluções ainda contêm erros e não conseguem adaptar a mudanças drásticas de consumo. Para resolver este problema é proposto um controlo adaptativo capaz de eficientemente actualizar em tempo real a estratégia de bombeamento com base nos desvios monitorizados relativamente à previsão. Esta metodologia toma em consideração uma referência optimizada para continuamente fazer as actualizações mais eficientes à estratégia de bombeamento. Para validar o controlo adaptativo, dois casos de estudo foram explorados: (i) uma rede simples composta de uma bomba e um tanque, (ii) e a de rede de referência de Richmond. Ambas as avaliações entregaram resultados positivos melhorando a eficiência a nível de custo. A combinação de previsões de consumo de água com metodologias de controlo adaptativo providencia uma solução confiável e eficiente para controlo automático de redes de distribuição de água. Este modelo de controlo pode se tornar uma característica essencial na tecnologia emergente “water grids” fechando o ciclo de controlo no sistema.



**keywords**

Adaptive Algorithm, Pumping Strategy, Cost-Efficiency, Water Distribution Network, Control Model, Adaptive Controller.

**abstract**

Modern cities have water distribution networks (WDN) that reliably meet the water demand of every individual household. These networks rely on pumps to move water from distant sources to the consumer. If inefficiently managed, this energy consuming process can become very costly. Using emerging computer power, simulation technologies and sensing devices, many techniques were developed that produce the most cost-efficient operational strategies. These methodologies rely on water consumption predictions to provide optimal pumping strategies. However, these predictions always contain errors, which may create control problems. Many efforts were made to develop progressively better predictions, some of which can change its parameters in real time. Nevertheless, these solutions still contain errors and cannot adapt appropriately to sudden changes in demand. To solve this problem, an adaptive controller that can efficiently update the pumping strategy based on monitored deviations of the predicted consumption is proposed. This methodology takes into account the tariffs of electricity over time and an optimal reference to continuously make the most cost-efficient updates in the pumping strategy. To validate the adaptive controller, two case studies were used: (i) a simple pump-reservoir network and (ii) the Richmond benchmark network. Both evaluations delivered positive results achieving the desired reliability while improving cost efficiency. The combination water consumption predictions and adaptive control methodologies provide a reliable and cost-efficient solution to operate a WDN automatically. This control model may become an essential feature in emerging water grids technology by closing the loop in the control system.



# Table of Contents

<b>1</b>	<b>Introduction</b>	<b>1</b>
1.1	Motivation	1
1.2	Framework	2
1.3	State of the Art	7
1.4	Objectives	11
<b>2</b>	<b>Methodology</b>	<b>13</b>
2.1	Controller Design	14
2.2	Adaptive Scheme	16
2.2.1	Hierarchy Control Update	16
2.2.2	Sensitivity Analysis	19
2.2.3	Constraint Validations	21
2.2.4	Decision-Making Algorithm	23
<b>3</b>	<b>Validation, Results, and Discussion</b>	<b>27</b>
3.1	Implementation	27
3.1.1	Simulation Framework	27
3.1.2	Evaluation Criteria	29
3.1.3	Type of Tests	30
3.1.4	Requirements Process	38
3.2	Results and Discussion	41
3.2.1	Subsystem F	41
3.2.2	Richmond Network	52
<b>4</b>	<b>Conclusion</b>	<b>61</b>
4.1	Final Remarks	61
4.1.1	Achievements	61
4.1.2	Limitations	62
4.1.3	Final Notes	62
4.2	Future Work	63
	<b>References</b>	<b>65</b>





# List of Figures

Fig.1 – Main sectors of a water supply system from the source to the end user [9].	2
Fig. 2 – Smart water grids technology scheme [8].	4
Fig. 3 – Smart water network typical layout [7].	5
Fig. 4 – Scheme describing the optimal operation of WDN using a SCADA system [9].	6
Fig. 5 – Dynamic Real-time Adaptive Genetic Algorithm – Artificial Neural Network [6].	7
Fig. 6 – Adaptive LQR control model for pumping stations [16].	9
Fig. 7 – Adaptive control architecture.	14
Fig. 8 – Flow sequence of the adaptive controller.	15
Fig. 9 – Best pumping options at the control increment $k = 0$ for negative disturbance.	18
Fig. 10 – Best pumping options at control increment $k = 0$ for positive disturbance.	19
Fig. 11 – Flow diagram of the decision-making algorithm.	24
Fig. 12 – Subsystem F network scheme [26].	28
Fig. 13 – Richmond network scheme [11].	29
Fig. 14 – Average water consumption bias for the subsystem F network, test 1.	33
Fig.15 - Water consumption for over biased deviation in subsystem F, test2...	33
Fig. 16 - Water consumption for over biased deviation in Richmond network, test 2.	34
Fig. 17 - Water consumption for lower biased deviation for the subsystem F, test 3.	34
Fig. 18 - Water consumption for lower biased deviation for the Richmond network, test 3.	35
Fig. 19 - Water consumption for noisy averaged biased deviation for the subsystem F, test 4.	35
Fig. 20 - Water consumption for noisy averaged biased deviation for the Richmond network, test 4.	36
Fig. 21 - Water consumption for higher over biased deviation in subsystem F, test 5.	36
Fig. 22 - Water consumption for fire situation with average biased deviation in subsystem F, test 6.	37
Fig. 23 - Water consumption for fire situation with average biased deviation in Richmond network, test 6.	37
Fig. 24 - Water consumption for average biased deviation with missing data for the subsystem F, test 7.	38

Fig. 25 – Linear relation between pumping time and water level of the tank for subsystem F .....	39
Fig. 26 – Results for average consumption bias test: (a) chart that represent the reliability success of each controller, (b) chart that represent the average cost for each control method, (c) Water level of the tank for each control method, (d) Pumping strategy for each control method. ....	45
Fig. 27 – Results for overconsumption bias test: (a) chart that represent the reliability success of each controller, (b) chart that represent the average cost for each control method, (c) Water level of the tank for each control method, (d) Pumping strategy for each control method. ....	46
Fig. 28 – Results for underconsumption bias test: (a) chart that represent the reliability success of each controller, (b) chart that represent the average cost for each control method, (c) Water level of the tank for each control method, (d) Pumping strategy for each control method. ....	47
Fig. 29 – Results for noisy average consumption bias test: (a) chart that represent the reliability success of each controller, (b) chart that represent the average cost for each control method, (c) Water level of the tank for each control method, (d) Pumping strategy for each control method. ....	48
Fig. 30 – Results for higher overconsumption bias test: (a) chart that represent the reliability success of each controller, (b) chart that represent the average cost for each control method, (c) Water level of the tank for each control method, (d) Pumping strategy for each control method.....	49
Fig. 31 – Results for Fire situation with average consumption bias test: (a) chart that represent the reliability success of each controller, (b) chart that represent the average cost for each control method, (c) Water level of the tank for each control method, (d) Pumping strategy for each control method. ....	50
Fig. 32 – Results for missing data situation with average consumption bias test: (a) chart that represent the reliability success of each controller, (b) chart that represent the average cost for each control method, (c) Water level of the tank for each control method, (d) Pumping strategy for each control method. ....	51
Fig. 33 – Forecasted water level of the tanks for the Richmond network. ....	54
Fig. 34 – Results for fire situation test: (a) the water level of every tank of the Richmond network with the reference control strategy and, (b) with the adaptive control strategy. ....	55
Fig. 35 – Results for average consumption with noise test: (a) the water level of every tank of the Richmond network with the reference control strategy and, (b) with the adaptive control strategy.....	56
Fig. 36 – Results for overconsumption test: (a) the water level of every tank of the Richmond network with the reference control strategy and, (b) with the adaptive control strategy. ....	57

Fig. 37 – Results for underconsumption test: (a) the water level of every tank of the Richmond network with the reference control strategy and, (b) with the adaptive control strategy. .... 58



## List of Tables

Table 1 – Price tariff over the day.....	16
Table 2 – Type of test performed to evaluate the performance of the adaptive controller .....	32
Table 3 – Constraints for the tanks of the Richmond network .....	38
Table 4 – Constant Pump-Tank relations for the Richmond network .....	40
Table 5 – Cost of operation for all tests performed for each control method ....	59



# Nomenclature

Symbol	Description	Unit
$d$	Disturbance.	[m]
$k$	Control increment.	[-]
$y_{\text{opt}}^k$	Forecasted water level of the tank at control increment $k$ .	[m]
$y^k$	Measured water level of the tank at control increment $k$ .	[m]
$x_{\text{opt}}^{k,\dots,nInc} = [x_{\text{opt}}^0, \dots, x_{\text{opt}}^k, \dots, x_{\text{opt}}^{nInc}]$	Initial optimal pumping strategy.	[min] or [%]
$y_{\text{opt}}^{k,\dots,nInc} = [y_{\text{opt}}^0, \dots, y_{\text{opt}}^k, \dots, y_{\text{opt}}^{nInc}]$	Initial forecast of the water level of the tank over the whole control period.	[m]
$x^k$	Pumping time at control increment $k$ .	[min] or [%]
$nInc$	Number of control increments in a 24 h control period.	[-]
$x^{k;k,\dots,nInc} = \begin{bmatrix} x^{0;0} & x^{k;0} & x^{nInc;0} \\ - & - & - \\ - & - & - \\ - & - & - \end{bmatrix}$	Pumping strategy at $k$ .	[min] or [%]
$x^{k+1;k,\dots,nInc}$	New pumping strategy at $k + 1$ .	[min] or [%]
$y_{\text{est}}^{k;k,\dots,nInc} = \begin{bmatrix} y^{0;0} & y^{k;0} & y^{nInc;0} \\ - & - & - \\ - & - & - \\ - & - & - \end{bmatrix}$	Estimation of the water level of the tank for the whole control period at $k$ .	[m]
$y_{\text{est}}^{k+1;k,\dots,nInc}$	Estimation of the water level of the tank for the whole control period at $k$ .	[m]
$i$	Adaptation option.	[-]
$l$	Number of adaptation options.	[-]

$t_p$	Array with the price levels of each control increment $k$ .	[-]
$p_h^{k;i,\dots,l}$	Hierarchy control update vector at control increment $k$ .	[-]
$\Delta y$	Variation of water level of the tank.	[m]
$\Delta x$	Amount of pumping time that increases or decreases the water level by $\Delta y$ .	[min] or [%]
$m$	Constant relating the amount of pumping time with the amount of water level in the tank.	[m/min]
$h_{\min}$	Minimum water level of the tank.	[m]
$h_{\max}$	Maximum water level of the tank.	[m]
$\mathbf{k}_v^k$	Control increment $k$ at which the constraints are violated.	[-]
$p_{hv}^{k;i,\dots,l}$	Hierarchy control update that validates the constraints.	[-]
$\Delta x_{\text{correct}}$	Amount of pumping time necessary to correct the disturbance.	[-]
$b^k$	Buffer amount at control increment $k$ .	[-]
$b_0$	Initial buffer parameter.	[-]
$\mathbf{x}_{\text{adp}}^i$	Amount of time to adapt at adaptation option $i$ .	[min] or [%]



# 1 Introduction

---

*“The cornerstone of any healthy civilization is access to safe drinking water.” (Larry W. Mays)*

*“One of the most vital services to industrial growth is an adequate water supply system”  
(Larry W. Mays)*

*“Water not only feeds bodies, but it also feeds countries.” (SENSUS, 2012)*

## 1.1 Motivation

Water is undeniably one of the most essential elements of life. Historically, civilizations would sprout in the vicinities of vast water reservoirs, such as Mesopotamia. Besides that, ready access to safe drinking is one of the best predictors of life quality and progress [1].

The creation of water distribution networks facilitated the access to places where before it was impossible. This allowed civilization to spread to other areas of the globe [1] and have access to additional resources.

Nowadays, the dependency on water has grown to industrial levels and it's fundamental for the economy, having influence in every single sector. This is another indication that as society evolves, so does the dependency on water. With the increase in water demand, it also increases the energy demand to operate a WDN. Therefore, it's paramount to build ever more productive, reliable, and optimal WDN to support civilization constant growth.

*“If we dare to dream of a future utopia, we must first work towards a utopic water distribution system” (Marcelo Manteigas 2019)*

## 1.2 Framework

A water distribution network (WDN) is an infrastructure with the primary purpose of moving water from distance sources to the individual consumer in the required quantity and at sufficient pressure [1].

Without a WDN, it's extremely difficult to populate the most remote areas of the world. It allows cities to spread away from water sources, making it possible to explore other resources. This shows the relevance of the impact a WDN has on modern society. Most modern cities already have robust and reliable infrastructures of WDN. Such infrastructures are composed of several sections, with different purposes.

Figure 1, illustrates the mains sectors of the course of water from its source until the final consumer. Although most of the process is done harnessing the power of gravity, it still is necessary to resort to pumping stations to move the water at adequate pressure, from its abstraction until its destination. Therefore, to effectively operate a WDN, the crucial decision that must be made is which pumps should be operated at any given time, as Walski pointed out [2]. This decision faces 3 very important competing goals: (i) maximize reliability, customers must always have access to water; (ii) minimize energy cost, the supply systems have to meet the demand while efficiently operating the network; (iii) Meet water-quality standards, which involves reducing the time water stays in storage tanks.



Fig.1 – Main sectors of a water supply system from the source to the end user [9].

To operate the pumping stations it is required electrical energy, which means that managing a WDN involves both the responsibility of reliably moving water and managing energy consumption. In fact, the global water supply represents a significant portion of global energy consumption, which equates to about 7% of all energy consumed [3]. Thus, the water sector has increased responsibility for the sustainable use of this planet resources since it handles two of the most important: water and energy.

This poses a massive opportunity for potential solutions since any small tool created to attenuate water waste products generates a significant positive impact on reducing the global expense of moving and managing water. It is also estimated that 30% of water is lost due to water leakages in the WDN, meaning a similar portion of the energy is also lost [4], furthermore, the inefficient operation

of pumps may represent an equal amount of waste. This opportunity is expected to be even higher in the future, as it's predicted through the population growth trends and industry development. The forecast indicates that the water industry will reach the trillion-dollar mark by 2050 [4]. This is a clear indication of the potential technological advancements that have to be explored, both for economic benefits but also for the sustainability of the planet.

The indicators of high energy consumption are immediate reflectors of energy costs concerning the operation of WDN. If this consumption is not well managed, this can generate dramatically high energy bills for any given institution. Managing energy might mean different things, depending on the industry. In the water industry, given the electricity price fluctuation over time, means that water should be pumped when possible at periods where the price is lowest. To address this opportunity, the field of automation, control, and optimization have been extensively developed in the academic community. Most of the work accomplished in recent years falls under the umbrella of reducing energy cost without compromising the network reliability and water quality. According to Feldman [5], the main improvements in energy efficiency can be obtained with; (1) pumping stations design improvement; (2) systems design improvement; (3) variable speed drives (VSD) installation; (4) efficient operation of pumps and; (5) leakages reduction through pressure modulation.

Although the opportunity is clear and the technology is already here, the uptake of new procedures in practice has been somewhat disappointing with relatively few being applied to real WDN [6]. The resistance in adopting models mentioned before by the water industry is partly because they are generally complex, involving a considerable amount of mathematical sophistication and substantial computational power, that increases with the size of the network [6]. Besides that, the techniques are confined to minimizing energy cost and largely ignore the network performance.

For the better acceptance of the methods by the industry, the solutions must be holistic, reliable, and simple to use. It is vital to develop robust software applying the similar methods with; (a) intuitive and attractive graphics interfaces, (b) easy adaptation to new situations and, maybe the most critical issue, (c) paying specific attention to the network performance and the consumers supply requirements [6].

To address this necessity, an IoT based technological solution named smart water grids has been developed. "*A Smart Water Network is the collection of data-driven components helping to operate the data-less physical layer of pipes, pumps, reservoirs, and valves*" [7]. Figure 2, shows the typical scheme of smart water grids technology. This technology makes it possible to leverage the

data collected about the network for an improved, streamlined, and efficient operation.

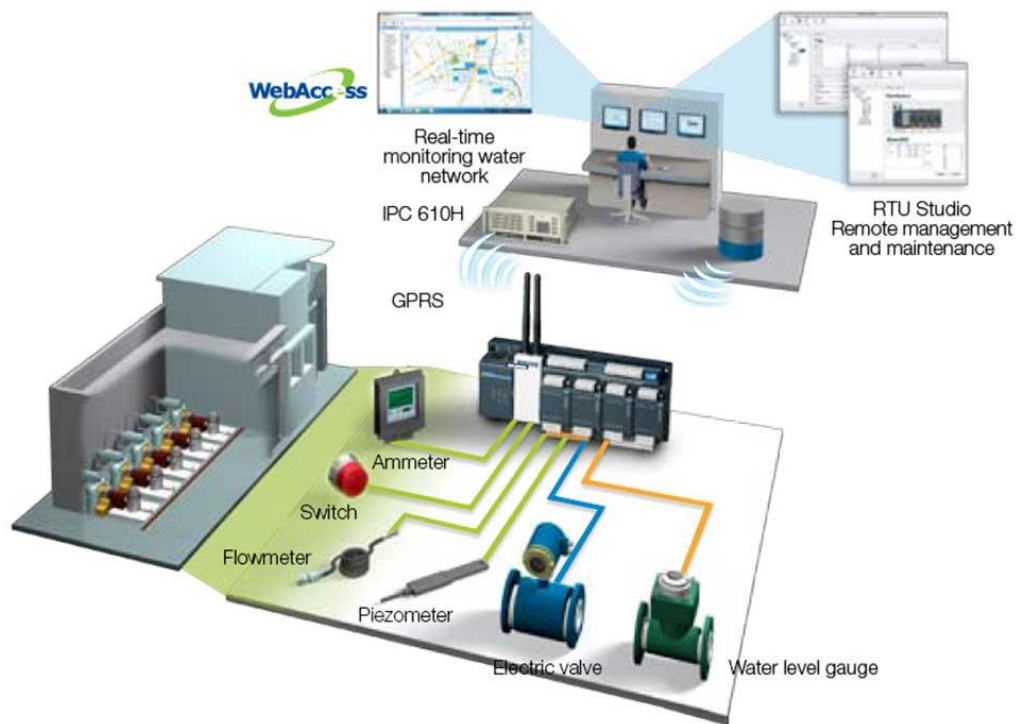

Fig. 2 – Smart water grids technology scheme [8]

A smart water network is composed of five different layers as layout in figure 3; (1) Automation and control tools in the physical layer, for the automatic and remote execution of actions/tasks received by means of real-time communication channels. (2) Measurement and sensing devices, to collect data from the networks (flow, pressure, water quality, etc.); (3) Real-time communication systems, to gather the collected data and/or to send execution actions (e.g., pumps or valves shut-off); (4) Data management software, to efficiently, handle the collected data by means of automatic processing; (5) Real-time data analytics and modelling software, to obtain useful insights from the network data, monitor and evaluate the potential impact of possible changes in the network (e.g. patterns detection, predictive analysis of control scenarios, etc.) [9].

To sense and control is implemented a SCADA that manages the real-time operations. This allows online operational adjustments to possible variations in the network, such as sudden fluctuations in demand, contributing to the efficiency improvements of the WDN. A SCADA system is composed of one or more field data interface devices such as reservoir level meters, water flow meters, valve position transmitters, power consumption meters, and pressure

meters. Thereby, the main functions of a SCADA system are; (1) data acquisition, (2) data communication; (3) data presentation and; (4) control [9]. Figure 4 illustrates how it could be implemented a SCADA system for WDN simplistically, in a smart water grids context.



Fig. 3 – Smart water network typical layout [7].

The fundamental goal of this emerging water grids technology is to introduce an automatic control in an “intelligent” way that surpasses that of a human operator. Having access to information the network, it’s possible to create hydraulic models that predict water consumptions. With this insight about the network, it’s possible to apply methodologies to calculate optimal operational strategies, like cost efficient pumping strategies. Through combining mathematical modeling with data sensing devices, this technology can highly improve the performance of the network. However, this is only possible when the hydraulic simulators are adequately calibrated and reflect the real operational characteristics of the network.

The smart water grids technology relies on robust mathematical formulations that manage all the data received concerning the network. A lot of work has been developed to create features that improve its performance. As highlighted at the beginning of this section, any small improvement in the management of water has the potential to produce excellent results due to scale effects. Most improvements are based in refining the quality of water consumption predictions. Recently, solutions based on artificial neural networks have also been explored, having succeeded in surpassing the accuracy performance of hydraulic modeling at representing the network. Yet this is only possible when there is access to large amounts of data about the network, which is not the case for the vast majority of WDN [10].

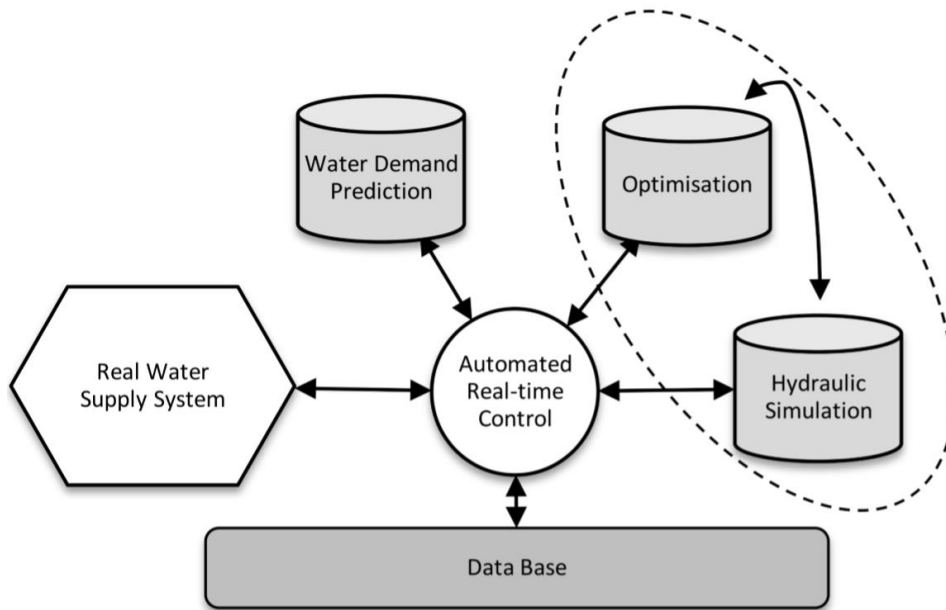

Fig. 4 – Scheme describing the optimal operation of WDN using a SCADA system [9].

As the next section demonstrates, predictions are always accompanied by errors, and sometimes water consumption might unexpectedly deviate from what is expected. These situations can create control problems and reduce the performance of the network. Dealing with these problems is a central argument in developing automatic systems that can operate in closed loop control for WDN. Emerging reliable technology to run WDN's is of great interest to institutions that provide this service. Thus this work fits in the framework of improving the usability and end result of these technologies by developing tools that address these problems.

### 1.3 State of the Art

To effectively control a pumping stations, the decisions must be made having in mind that the customer must always have access to water. After assuring the demand is met, the next goal is to perform this task in the most cost-efficient way. Different strategies have been devised to meet this goal, and the most recent are based on water consumption forecasts. These advancements were made possible due to recent technological developments. In most modern water services institutions, some form of hydraulic modeling, followed by predictions of water consumption and optimal pumping strategies are used to assist the operator in making the best decisions [11].

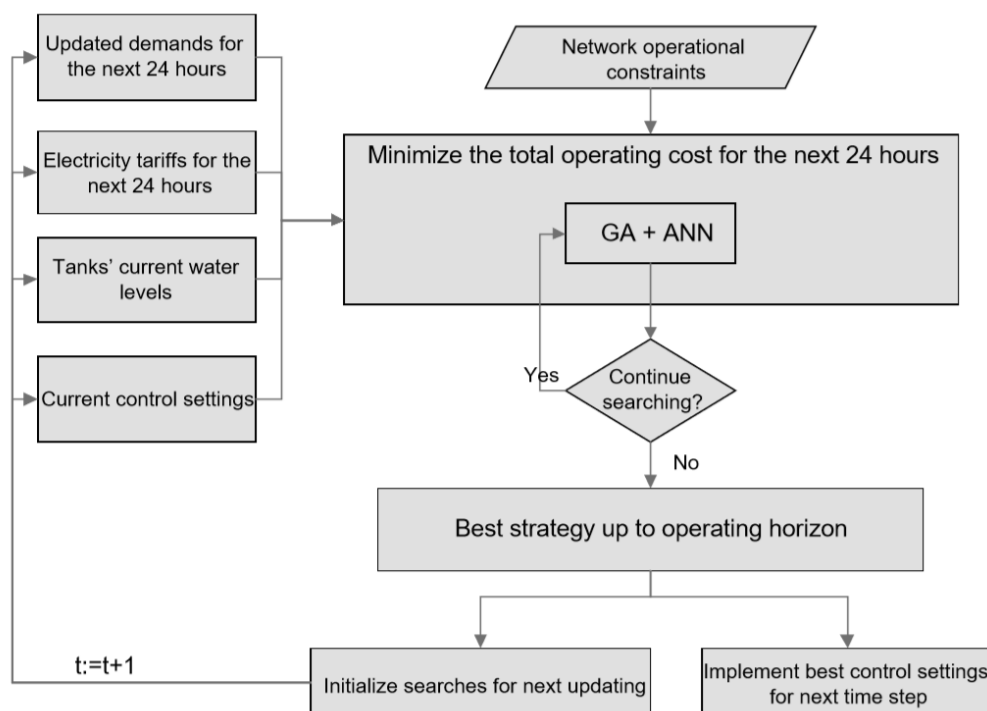

Fig. 5 – Dynamic Real-time Adaptive Genetic Algorithm – Artificial Neural Network [6].

Although this control methodology is very effective at producing the most cost-efficient operational strategy, it requires additional control from an operator to account for unpredictable changes in demand or unexpected errors in the forecasting. In real time operations, the monitored water consumption is often different from the predictions. These types of controllers do not have the ability to adapt to changes and therefore are weak alternatives to implement in closed-loop control systems [12].

Some systems that try to bypass this problem were designed, such as the DRAGA-ANN( Dynamic Real-time Adaptive Genetic Algorithm – Artificial Neural

Network) [6], a fully adaptive forecasting model proposed by Bakker [13] and the PAWN (Parallel Adaptive Weighting model) [14], that to some extent can adapt to changes in the environment by continuously adjusting their forecasts based on new readings of the network. Figure 5 demonstrates the algorithm used by the DRAGA-ANN system to achieve this purpose. These models can make reliable forecasts of the water consumption, which make possible the creation of optimized strategies to operate the pumping stations, however they are not robust to unexpected changes. They are suitable for real-time operations but it's necessary supervision from the operators.

A solution to this reliability problem is the typical reactive controller. These controllers don't use any sort of "intelligence" to control network and are often single objective. The simplest one's work on the basis of keeping the water level within a certain level. This strategy might be very cost inefficient since it doesn't leverage the knowledge about the network. Instead, it's continuously reacting to the demand and adapting the state of the pumps accordingly. Although this methodology does not produce the most cost-efficient strategies, it can reliably assure a closed loop control.

A simple PI (proportional–integral) controller was created for the control of a pumping stations of a WDN but seemed to be unsuitable for solving the problem of effective water distribution control canals characterized by significant time-varying dynamical parameters. The PI controller has the best performance only in nominal conditions, which is not the case of a WDN dynamic [15].

A more sophisticated reactive controller is the adaptive controller. Figure 6 shows the scheme of an adaptive controller design proposed by Elbelkacemi [16]. This architecture is composed of a controller that executes the actions, the plant (or the system to be controlled) that receives such instructions and outputs its response, and an adaptive scheme that results from the combination of a parameter estimation and control design that continuously adapts the controller execution strategy. The use of this controller has benefits; it allows a high-performance control of the system and provides fine tuning of the controller when the reaction of the plant is unknown or time-varying. It has the ability to solve through good approximation some nonlinear stochastic control problems, that can't be simply solved through gain scheduling [17].



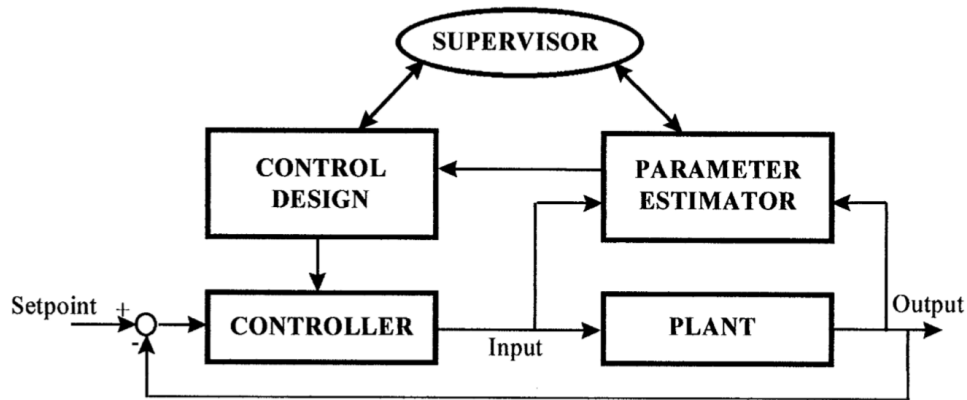

Fig. 6 – Adaptive LQR control model for pumping stations [16].

There are many applications that rely on adaptive controllers to extract the best possible control results. In the water industry, this tool has been applied for water quality control, such as the one created and tested by Zhong [18] and KIOS research center [19]. Shengwei Wang also suggested the application of adaptive controllers to operate variable speed drives [20].

An adaptive controller was built to automatically operate a decentralized water distribution network, with more than 20 pumps to provide water into an agriculture field. This controller main objective is to stabilize the water level of the tanks while reducing water waste products. Although it's designed to reduce the cost of pumping, it didn't consider the electricity tariff price in its operation. However, the complex mathematical formulation made it impractical to implement this model in larger systems. Besides that, the controller was single objective, only considering the water level of the tank [21]. A similar model for a simple network has also been implemented by Rivas Pérez [22].

Another real-time optimal controller was designed and tested to work on a water supply system of river Basis [23]. The result is a single objective controller, that was tested using 2 different controller designs; (i) the LQR (linear quadratic regulator) and, (ii) MPC (model predictive controller). The controllers had two working frameworks, one dedicated to controlling the water tank level, and the other to control the constant water inflow. Although the results were reasonably good at having a prompt response to disturbance, the control models were not adaptive to the time-varying nonlinear dynamics of a WDN. The model was implemented and tested successfully but was limited to work in open loop. The LQR control algorithm, when combined with an adaptive scheme, has shown better results to control the flow of water, being successful at regularizing the pumping discharges to face the oscillation of demand. However, it doesn't consider the pumping cost in its control objectives. A similar controller was

designed with a focus on energy efficiency but didn't take into consideration the electricity price table [24].

There are many adaptive controllers being used to control pumping stations in water distribution networks, although they are successful at dealing with the nonlinear dynamics of WDN, most of them are single objective and mathematically complex, posing a limitation to their application in city-sized WDN, where the solutions must be holistic and straightforward to be implemented [22].

Essentially these are the two state-of-the control methodologies used in pumping stations; one is based on developing extensive insight about the networks that make possible the use of forecasts to leverage the decisions taken by operators. It can work automatically in real-time operations. However, it's necessary to have some form of supervision from an operator by introducing machine interaction through visual interfaces and alarms to assure the reliability of the systems. The other solution for this concern can reliably control a WDN automatically in closed-loop, by operating on constant feedback with the real monitored readings of the network. The adaptive controllers are more successful with this task. However, the cost of the operation is often not taken into account since the strategies are single cycled, making it less attractive for institutions.

## 1.4 Objectives

Having studied the literature concerning the control methodologies for the water distribution network, it is clear that the evolution of solutions has diverged into two different realms of thought. One is based on leveraging vast amounts of data to produce the best operational strategies. The other focuses on constant monitoring of the network to make online adjustments to the pumping stations. Although some solutions have tried to integrate both ideas, such as building evolving predictions by monitoring the networks, these are far from perfect and aren't reliable enough to close the control loop. This means that these methodologies still need user input to run without compromising access to water to the final consumer.

If the objective is to create a functional software feature for the emerging water grids technology to deliver a fully automatic solution to water service providers, an adaptive control methodology might work well, however, due to the lack of consideration over the cost of operation, this solution is not liable to be accepted by the water industry.

There is a clear gap in the literature in experiments that try to develop methodologies that fully merge the advantages of both ideas. Create a controller that can adapt to the environment response, but that also considers the forecasts and knowledge about the network.

The hypothesis is that the solution is to develop a control algorithm that can adapt the previous optimally calculated parameters on the basis of the environment changes. Creating an adaptive controller, that doesn't adjust to the real consumptions but rather that operates by nullifying the disturbances created by an operating strategy that follows a water consumption forecast.

Thus, the objective of this work is to develop a new methodology to operate the pumping stations that aims at surmounting the current automatic control strategies, and that might become a better fit solution for the emerging water grids technologies.



## 2 Methodology

---

As suggested in the previous section, there is high potential to explore the merging of the two control strategies; (i) control based on forecasts and, (ii) control based on adaptation to continuous measurements of the network state. To accomplish that, the architecture of the controller is similar to the one proposed by Elbelkacemi [16] in figure 6, with a different adaptive algorithm. The adaptive scheme in adaptive controllers uses the online readings of the network to calculate new parameters for the controller. For this project, the adaptive scheme is designed to use these same online readings to nullify the disturbance measured by comparing the real consumptions of the network with the calculated forecast. The disturbance  $d$  is calculated as;

$$d = y_{\text{opt}}^k - y^k, \quad (1)$$

where  $y_{\text{opt}}^k$  is the predicted water level of the tank at control increment  $k$  based on the water consumption forecast and optimal pumping strategy  $x_{\text{opt}}^{k,\dots,nInc}$ , the  $y^k$  is the measured (or real) water level of the tank at the control increment  $k$ .

The disturbance  $d$  is calculated at every control increment  $k$  and the objective of the adaptive controller is to continuously nullify it in order to allow the cohesion of the initial pumping strategy over time. In a different way of thinking, the disturbance  $d$  can be seen as an indicator of the accuracy of the forecast, and the purpose of the adaptive controller is to minimize this error in real time. To achieve this purpose, the initial pumping strategy  $x_{\text{opt}}^{k,\dots,nInc}$  must be continuously updated.

The adaptation to the measured disturbance  $d$  is made by intelligently updating the initially introduced pumping strategy  $x_{\text{opt}}^{k,\dots,nInc}$ , considering the cost efficiency and the reliability of the process. The adaptive scheme seeks for the time periods where the price of electricity is lowest (or highest, depending on whether the disturbance is positive or negative) while respecting the safety constraints of the system.

The final result is a pumping strategy that uses the water consumption forecast to produce an initial optimal reference, which is updated continuously by the adaptive scheme through monitoring the real water consumption of the network. The new pumping strategy  $x^{k;k,\dots,nInc}$  established by the adaptive controller at control increment  $k$  is an updated version of the initially introduced optimized pumping strategy, that better fits the actual demands of the WDN.

## 2.1 Controller Design

The proposed control model follows a standard adaptive controller architecture, such as the one represented in figure 7. The controller is the combination of 3 main modules: (i) the controller module, (ii) the network module, and (iii) the adaptive scheme module. These modules are in constant interaction with each other. This interaction is sequential, as it is represented in figure 8. The cycle is repeated at every control increment  $k$ , this is the chosen amount of time at which the adaptive controller monitors de network and performs adaptations.

Typically, the amount of time used for the control increment  $k$  ranges from 15 minutes to 1 hour, corresponding to  $nInc = 96$  or 24 control increments  $k$ , in a 24-hour day, respectively.

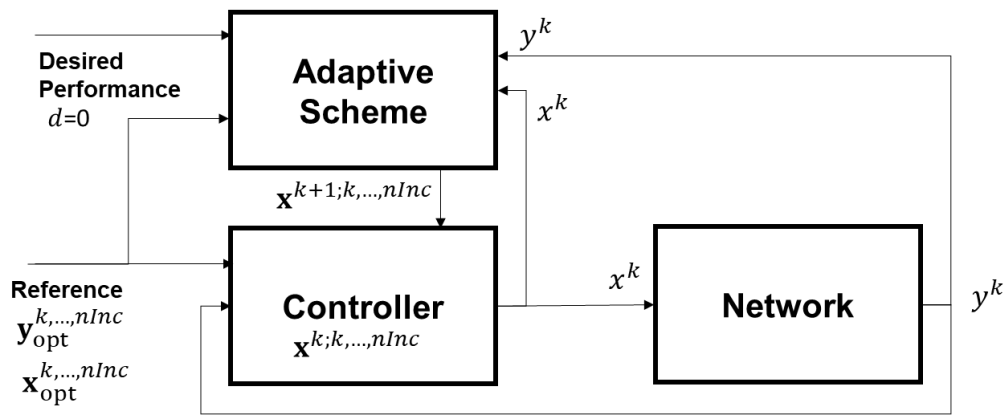

Fig. 7 – Adaptive control architecture.

At every control increment  $k$ , the controller module executes the pumping instructions  $x^{k;k,...,nInc}$  by sending information about the amount of time the pumps are switched on  $x^k$  to the network module. The network module receives and executes the instructions and sends the monitored water level of the tank  $y^k$  to the adaptive scheme module. The adaptive scheme uses this information to produce a new pumping strategy  $x^{k+1;k,...,nInc}$  that better adjusts to the demands. This new strategy is then sent to the controller module to execute in the next control increment  $k + 1$ .

The network module is the water distribution network itself, which can be seen as a plant with unknown parameters inside. The plant responds to a specific input, the amount of pumping  $x^k$ , by delivering a measured output, the amount of water consumed by the network or the water level in the tanks  $y^k$ .

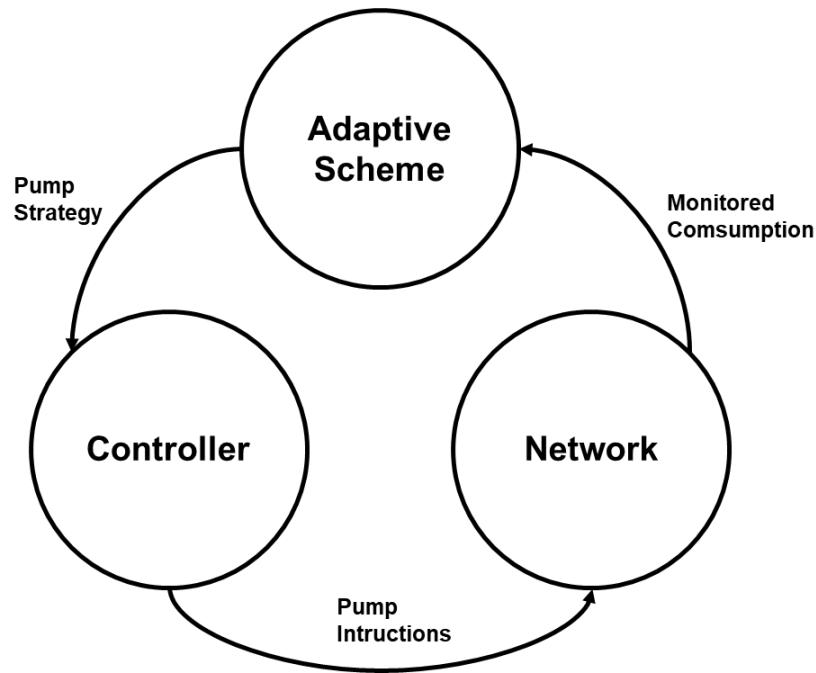

Fig. 8 – Flow sequence of the adaptive controller.

The controller module receives the updates, and operates by executing one of the following four decisions:

- 1- No adaptation – The controller doesn't receive a new pumping strategy  $\bar{x}^{k+1;k,\dots,nInc}$ , therefore executes the instructions  $x^k$  of its current strategy  $\bar{x}^{k;k,\dots,nInc}$ . This might happen in the case where there is missing information, and the adaptive scheme fails at creating a new pumping strategy to feed the controller;
- 2- Adaptation – The controller receives a new pumping strategy  $\bar{x}^{k+1;k,\dots,nInc}$  and follows the instructions  $x^k$  for that control increment  $k$ ;
- 3- Non-routine operation – the disturbance is substantially higher than expected and might signal future problems. The controller starts operating with a different strategy to assure reliability;
- 4- Send alarm – The monitored water consumption is significantly higher than expected, send an alert for help.

The adaptive controller continuously executes this set of actions in order to reliably and efficiently control the network by facing the changes in consumption when compared with the forecast.

## 2.2 Adaptive Scheme

Given the nature of the problem, the methodology focusses on meta-heuristics that follow the principles of adaptive algorithms to achieve the desired result. The following sub-sections explain each of the ideas used to develop the algorithm in the adaptive scheme.

### 2.2.1 Hierarchy Control Update

To produce the most cost-efficient results in energy consuming processes, it's necessary to take into consideration the tariffs of electricity over the day. Standard tariffs have periods of time where the price of electricity is highest and periods where the price is lowest. Table 1 suggests an example of a possible tariff. As it can be observed in table 1, for the same energy consumed, the cost can be up to 3 times higher. This observation can be extracted by comparing the cost of electricity between a very empty period and peak hours. Therefore, for the same process, the electricity bill differs depending on its timing.

Table 1 – Price tariff over the day.

Interval [h]	Period	Cost [\$/kWh]
[0 , 2 [	Empty	0.0737
[2 , 6 [	Very Empty	0.06618
[6 , 7 [	Empty	0.0737
[7 , 9 [	Full	0.10094
[9 , 12 [	Peak	0.18581
[12 , 24 ]	Full	0.10095

This is the central concept used to calculate an optimized pumping strategy  $x_{opt}^{k, \dots, nInc}$ . The adaptive scheme should update the pumping strategy  $x^{k; k, \dots, nInc}$  by seeking the most cost-efficient options, this way assuring that the new pumping strategy  $x^{k+1; k, \dots, nInc}$  aims at being cost-efficient. Practically, this means that the pumping strategy  $x^{k; k, \dots, nInc}$  is updated according to the measured disturbance  $d$  by adding or taking pumping time in the control increment  $k$  where it is obtained the highest benefit.

For example, if it is measured an excess in water consumption, the algorithm searches firstly for the possibility to increase the pumping time  $x$  in control increments where electricity price is lowest and then to highest accordingly. Conversely, if it is measured a reduction of water consumption compared with the prediction, it takes firstly pumping time  $x$  from control increments where electricity price is highest, followed by the lowest.



The purpose of this idea is to search through the remaining control period of 24 hours the most cost-efficient way to update the pumping strategy  $x^{k;k,\dots,nInc}$  based on the measured disturbance  $d$  while assuring that the water level of the tank stays within the established safe limits. The adaptive scheme is proactively finding the best adaptation solution over the 24-hour control period (or any other considered control period), instead of reacting to the measured disturbance  $d$  by adapting the strategy in the same control increment  $k$ .

In the end, this means that the adaptation follows an hierarchy-based methodology that prioritizes the system reliability while optimizing for a cost efficient operation. This hierarchy control update  $p_h^{k;i,\dots,l}$ , is created at every control increment  $k$ , in order to continuously make the most optimal decisions based on the forward increments  $k, \dots, nInc$ . Mathematically, this process is described in the following equations.

The first part is to establish the price hierarchy. To achieve this, a hierarchy function that attributes a level to the price of electricity for a given control increment  $k$  is used. This level is an integer that ranges from  $1, \dots, n$  where  $n$  is the number of different prices of a specific tariff. The scalar 1 indicates the lowest price level and  $n$  the highest. Mathematically this is described by the following equation,

$$\mathbf{t}_p = \text{hierarchy}(k, \dots, nInc), \quad (2)$$

where  $\mathbf{t}_p$  is the vector that holds the levels for all control increments  $k, \dots, nInc$ . Similarly,  $y_{est}^{k;k,\dots,nInc}$  is the vector that contains the estimated water level of the tank for all control increments  $k, \dots, nInc$ . With this information, it's possible to compile the hierarchy control update  $p_h^{k;i,\dots,l}$  using the  $\text{rank}_{\max}$  and  $\text{rank}_{\min}$  functions. The  $\text{rank}_{\max}$  function sorts the input vector from the highest to the lowest value, and it's used when the measured disturbance  $d$  is negative. Conversely the  $\text{rank}_{\min}$  function sorts the input vector from the lowest to the highest value, and it's used when the measured disturbance  $d$  is positive. Mathematically this is described by the following equation;

$$p_h^{k;i,\dots,l} = \begin{cases} \text{rank}_{\max}(\mathbf{t}_p \times nInc + y_{est}^{k;k,\dots,nInc}) & \text{for } d < 0 \\ \text{rank}_{\min}(\mathbf{t}_p \times nInc + y_{est}^{k;k,\dots,nInc}) & \text{for } d > 0 \end{cases}, \quad (3)$$

where  $p_h^{k;i,\dots,l}$  is the vector with that holds the adaptation options ranked from best to worst,  $i$  is the adaptation option, and  $l = nInc - k$  is the number of adaptation options.

The vector  $\mathbf{t}_p$  is multiplied by  $nInc$  in order to give it priority over  $y_{est}^{k;k,\dots,nInc}$ . This means that the cost of electricity has higher weight in creating the hierarchy control update vector. It is defined the best adaptation the control increment  $k$  that has the lowest price and the lowest water level of the tank, in case of the  $d > 0$ , and the control increment  $k$  that has the highest price and the highest water level of the tank, in case of the  $d < 0$ .

Figures 9 and 10 illustrate the methodology of the hierarchy control update  $p_h^{k;i,\dots,l}$ . Figure 9 shows the best pumping options found by measuring a negative disturbance  $d$  in control increment  $k = 0$ . Figure 10 shows the best pumping options found at measuring a positive disturbance  $d$  control increment  $k = 0$ . This example uses  $nInc = 24$  in a 24-hour period.

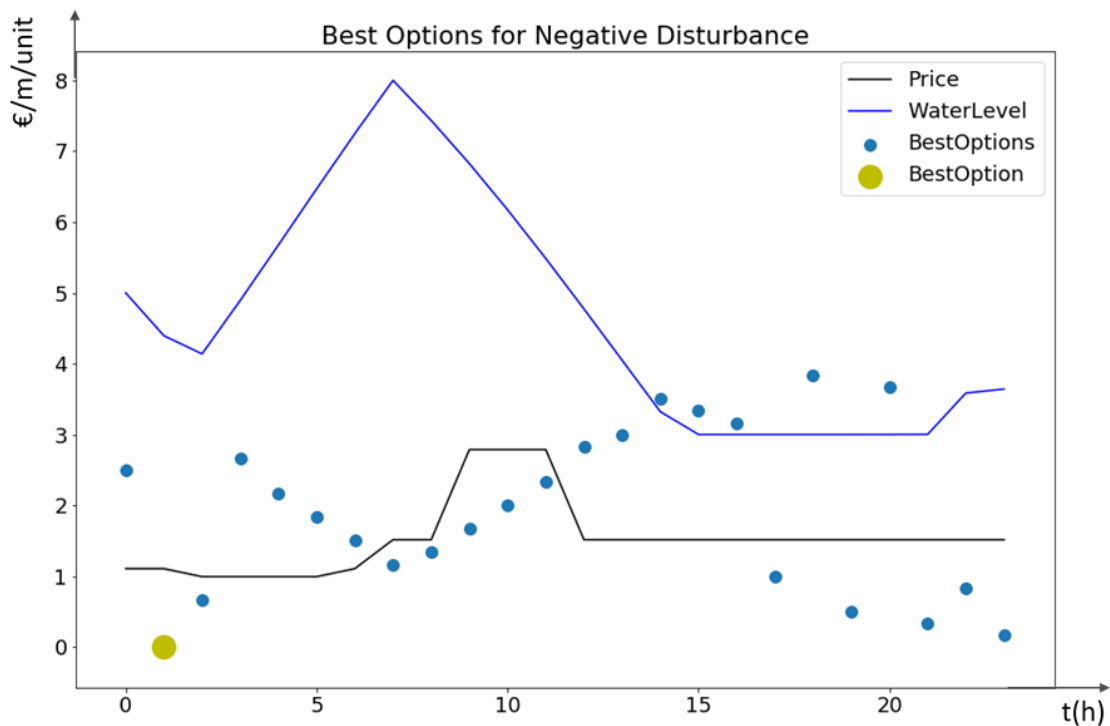

Fig. 9 – Best pumping options at the control increment  $k = 0$  for negative disturbance.

Through analyzing figure 9, it's clear that the first best pumping options found by the algorithm, when the measured disturbance is negative, are both the ones that have the lowest price and lowest water tank level. Take for example the best adaptation option highlighted by the big yellow circle; a careful analysis shows that it corresponds to the control increment  $k = 2$ , such that the cost of electricity corresponds to the level 1, and has the lowest water level of the tank among the other control increments belonging to that price level.

In case that the measured disturbance is positive, then the best adaptation options take a different solution. From figure 10, it can be seen that the hierarchy

methodology finds the opposite answer since it's more beneficial for the system to decrease pumping time when the electricity price and the water level are highest. Take for an example the best adaptation option highlighted by the big yellow circle; a careful analysis shows that it corresponds to the control increment  $k = 10$ , such that the cost of electricity corresponds to the level 4, and has the highest water level of the tank among the other control increments belonging to that price level.

In conclusion, the hierarchy pumping idea aims at continuously creating a sorted vector of the best adaptation options that the controller can make to correct the disturbance  $d$ , by adding or taking pumping time, starting from the best adaptation option until the worst. This obviously must take into consideration the previous pumping strategy  $x^{k;k,\dots,nInc}$ , in order to make valid adjustments to create the new pumping strategy  $x^{k+1;k,\dots,nInc}$ .

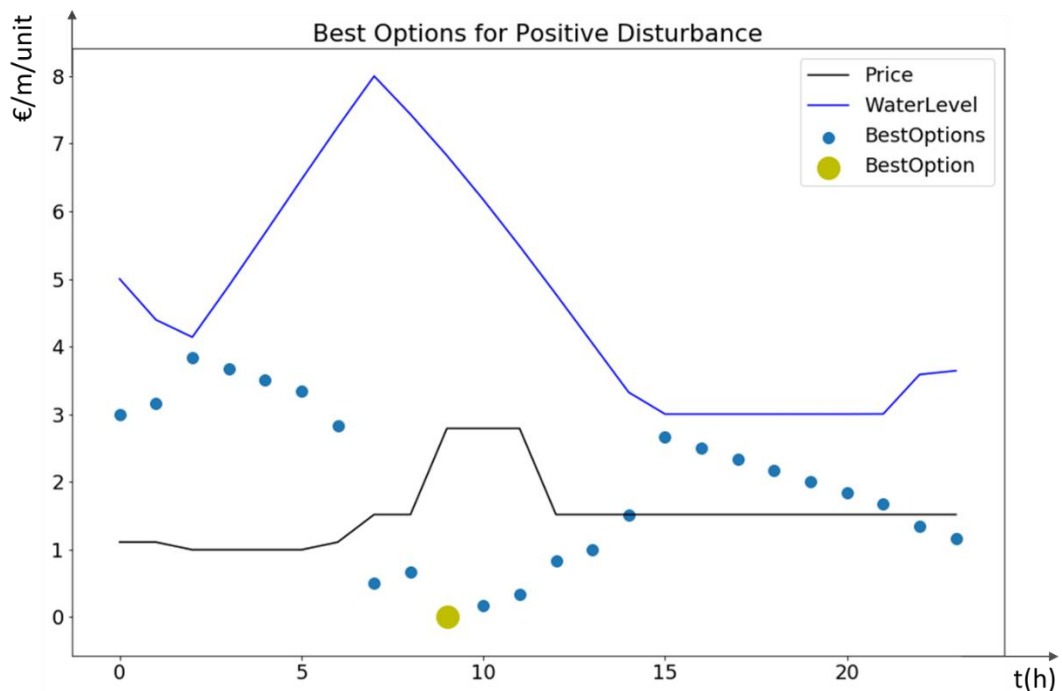

Fig. 10 – Best pumping options at control increment  $k = 0$  for positive disturbance

### 2.2.2 Sensitivity Analysis

In every control algorithm, it's necessary to derive a relationship between the control variable (or independent variable) and the observed variable (or dependent variable). In this specific control problem, the control variable is the

amount of time the pumps are switched on, and the observed variable is the water level of the tanks.

Considering now the network as the system to be controlled, that receives the pumping time instructions and outputs the water level of the tank, it's possible to extract a relation between these variables by testing the sensitivity of the system to the control variable. Mathematically, this is the same to determine the slope of the curve that relates both variables, such as,

$$\Delta y = m \times \Delta x, \quad (4)$$

where  $m$  defines the pumping time  $\Delta x$  for a certain amount of water in the tank  $\Delta y$ . The most effective strategy to determine the constant  $m$  is to simulate different pumping strategies in the network with increasing periods of time the pumps are switched on, and then observed the different responses of the system by measuring the water level of the tank. This data set can then be used to calculate a linear regression that describes the system. The following equation defines the process mathematically to determine the relation,

$$m = \frac{N \times \sum(x \times y) - (\sum x) \times (\sum y)}{N \times \sum(x^2) - (\sum x)^2}, \quad (5)$$

where  $N$  is the number of observations used.

For complex systems composed of more than one pumping and tank, this relationship becomes harder to deduct due to the dependencies between all the links and nodes composing the network. In this case the extraction of the tank and pumping relationship becomes more complicated, and it is necessary to recur to a simplification. The strategy focusses on simulating different cases for the states of the pumping in order to derive various points used to determine the constant by the same regression technique mentioned above. The result won't be as exact; however, it provides a close enough relationship to implement the algorithm. This relation can then be used to transform the measured disturbance  $d$  in the additional quantity of pumping time  $\Delta x_{\text{correct}}$  to correct it. The amount of pumping time that is necessary to add or take in order to nullify the observed disturbance is given by,

$$\Delta x_{\text{correct}} = d \times m. \quad (6)$$

A seemingly more straightforward approach is to use the pumping equations to determine this relationship. However, this approach is bounded to fail in most cases since it doesn't take into consideration all the variables of the network that affect the amount of water that is observed in the tank. A straightforward example is the existence of consuming points between the pumps and the tanks that evidently affects how much water is found in the tank. Besides

that, the intrinsic characteristics of the network might also affect the amount of water that reaches the tank. For these reasons, an experimental approach is a better way to study this relationship.

### 2.2.3 Constraint Validations

The reliability of the operation is more critical than operating a water distribution system in the most cost-efficient way. The water demand of the costumers must always be met. Therefore, the adaptive controller proposed in this work must respect this condition, such that in any adaptation suggested by the adaptation scheme, the water level constraints must be satisfied. The water level safe limits are set accordingly to each specific tank. The limits bound the water level by a minimum and a maximum value, and the control strategy must always take into account these boundaries. This is described mathematically by the following equation,

$$h_{\min} \leq y_{\text{est}}^{k+1;k,\dots,nInc} \leq h_{\max} , \quad (7)$$

where  $h_{\min}$  is the established lower bound of the water level,  $h_{\max}$  is the established upper bound of the water level, and  $y_{\text{est}}^{k;k,\dots,nInc}$  is the expected water level for the whole control period of the tank calculated at the control increment  $k$ , which is calculated through,

$$y_{\text{est}}^{k+1;k,\dots,nInc} = y_{\text{est}}^{k;k,\dots,nInc} + d. \quad (8)$$

This objective is partly accomplished with the hierarchy pumping idea since the adaptation in control increments where the water level of the tank is lower is prioritized. However, the cumulative effect of the applied or observed changes are reflected throughout the whole control period and the constraints can't be validated only considering that idea. Increasing the pumping time  $x^k$  in the control increment  $k$  increases the estimated water level of the tank  $y_{\text{est}}^{k;k,\dots,nInc}$  for the following increment  $k + 1, \dots, nInc$ . The cumulative effect of this operation must be addressed by taking into consideration the whole strategy when validating the constraints, such as highlighted in the previous equation. To accomplished this, the following rules are introduced:

#### 1. Adapt before violating

After calculating the expected water level of the tank knowing the impacted of the disturbance  $d$  by calculating the expected water level of the tank  $y_{\text{est}}^{k;k,\dots,nInc}$ , it's possible to determine if any constraint is violated and at which control increment  $k$ . This control increment can be determined by the following equation.

$$\mathbf{k}_v^{k,\dots,nInc} = \left\{ \begin{array}{l} 0 \text{ for } h_{\min} \leq y_{\text{est}}^{k+1;k,\dots,nInc} \leq h_{\max} \\ i \text{ for } h_{\min} \geq y_{\text{est}}^{k+1;k,\dots,nInc} \geq h_{\max} \end{array} \right\}, \quad (9)$$

where  $\mathbf{k}_v^{k,\dots,nInc}$  holds the control increments that record the violated constraints. Knowing the point at the which the limits are overpassed, it's possible to prevent by forcing the adaptation to be done before that control increment  $k$ . Therefore, the valid calculated adaptations by the hierarchy control update  $p_h^{k;i,\dots,l}$  are the ones such the respective control increment is smaller than  $k$  such that  $k_v^k \neq 0$ , mathematically,

$$p_{hv}^{k;i,\dots,v} = \{ p_h^{k;i,\dots,l} \text{ for } p_h^{k;i,\dots,l} < k_v^k \}, \quad (10)$$

where  $p_{hv}^{k;i,\dots,v}$  is the valid hierarchy control update vector and holds the sorted control increments  $k$ , from best to worst adaptation, that validates the imposed constraints and  $v$  is the number of valid adaptation options.

## 2. React to prevent

The water demand can fluctuate unexpectedly due to random events, such as a fire situation. In this case, the consumption of water might increase radically and, therefore, largely deviate from the forecast. To cope with that situation, the adaptive scheme has a mechanism to prevent the water demand is compromised. Basically, if the measured water consumption is consistently higher (or lower) than the calculated forecast, the adaptive scheme activates a reactive mechanism instead of the established proactive approach to deal with these occasions.

Using this mechanism, the adaptive controller can firmly guarantee the reliability of the operation preventing possible violations of the constraints and reacting to unusual situations.

This mechanism ignores the adaptive scheme actions and reacts by changing the pumping time in the current control increment. This is done using a buffer value that indicates the proximity of the water level to the established limits. This value, which is slightly lower (or higher) than the maximum (or minimum) level of the tank triggers this reactive mechanism. Therefore, the reactive mechanism is triggered if the condition described in the following equation is true;

$$h_{\max} - b^k \leq y_{\text{est}}^{k;k+2} \leq h_{\min} + b^k, \quad (11)$$

where  $b_k$  is the buffer value at control increment  $k$ . The magnitude of the buffer  $b_k$  changes over time, and it's directly proportional to the consistency of the anomaly, such as described in the following equations;

$$b^k = j^k \times b_0, \quad (12)$$

$$j^k = \begin{cases} |j^{k-1} + 1| & \text{for } d > 0 \\ |j^{k-1} - 1| & \text{for } d < 0 \end{cases}, \quad (13)$$

where  $j^k$  is the constant that multiplies by the initially established buffer value  $b_0$  at control increment  $k$  and  $j^{k-1}$  is the constant that multiplies by the initially established buffer  $b_0$  of the previous control increment  $k - 1$ . This mechanism assures the algorithm holds memory of rapid changes in the magnitude of deviations.

#### 2.2.4 Decision-Making Algorithm

The adaptive scheme must be incorporated with a mechanism that determines the best decisions to adapt to the measured disturbance. As highlighted by the previous sections, the decision-making process is bounded to a set of assumptions. To optimally perform this task, the decisions must be made sequentially and properly incorporate every stated principle. figure 11 presents a scheme of the methodology developed. The squared boxes in figure 11 hold the actions performed by the algorithm.

The algorithm starts by calculating the disturbance  $d$  using the real measure of the water level  $y^k$  and the optimal water level for that control increment  $y_{opt}^k$ . With that information, an initial estimation of the water level  $y_{est}^{k;k,\dots,nInc}$  for the whole control period is calculated. This information in combination with the previous pumping strategy  $x^{k;k,\dots,nInc}$  is used to create the framework of valid pumping update control  $p_{hv}^{k;i,\dots,v}$  that is used to make the decisions.

After determining the adaptations that nullify the disturbance, while respecting all the stated assumptions, it's produced a new pumping strategy  $x^{k+1;k,\dots,nInc}$  and a new estimation of the water level  $y_{est}^{k+1;k,\dots,nInc}$  for the following control increment  $k$ . This is again used to validate the constraints in order to predict any future failure of the system as highlighted in the section 2.2.3. At the end of this process, a new pumping strategy for the controller is outputted. The latest estimation of the water level for the whole control period is used to keep track of the influences that the adaptations and disturbance have on the operational strategy.

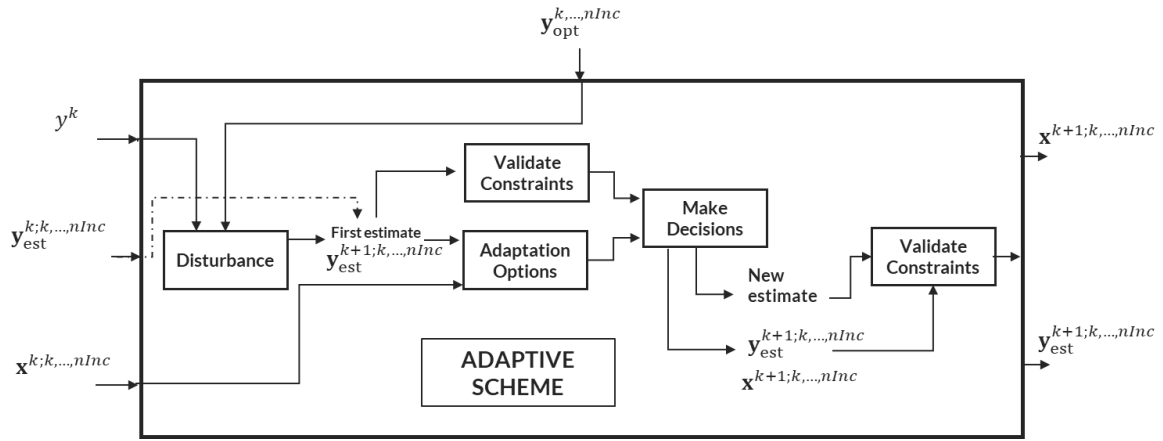

Fig. 11 – Flow diagram of the decision-making algorithm.

An important note relative to the adaptations in the decision-making process is that the disturbance can be nullified through a set of increments. To accommodate cases where the current strategy doesn't permit the change, such as in situations that  $x^k + \Delta x_{\text{correct}} > 1 \cup x^k - \Delta x_{\text{correct}} < 0$ , which is impossible since the input-variable  $x^k$  is in fact a fraction of time the pumps are on for each control increment and thus  $x^k \in [0,1]$ . Also  $y_{\text{est}}^{k+1;k,...,nInc} + \frac{\Delta x_{\text{correct}}}{m} > h_{\text{max}} \cup y_{\text{est}}^{k+1;k,...,nInc} - \frac{\Delta x_{\text{correct}}}{m} < h_{\text{min}}$  would violate the imposed constraints of the system, and therefore are not valid. For such cases, the adaptations can be distributed by various control increments such that validates the constraints of the system. In this case, it is necessary to calculate an additional variable that indicates the maximum possible change for a particular control increment  $k$ , as described by;

$$\mathbf{x}_{\text{adp}} = \begin{cases} (1 - x^{k;i,...,l}) & \text{for } d > 0 \cap \left( y_{\text{est}}^{k;i,...,l} + \frac{(1 - x^{k;i,...,l})}{m} \right) \leq h_{\text{max}} \\ (x^{k;i,...,l}) & \text{for } d < 0 \cap \left( y_{\text{est}}^{k;i,...,l} - \frac{(x^{k;i,...,l})}{m} \right) \geq h_{\text{min}} \\ 0 & \text{else} \end{cases}, \quad (14)$$

where  $x_{\text{adp}}^i$  is the amount of pumping time that can be taken or added for that control increment, according to the measured disturbance  $d$ . This value is used to perform the adaptation for that control increment  $k$  and update the  $\Delta x_{\text{correct}}$  in the following way;

$$\Delta x_{\text{correct}} = \Delta x_{\text{correct}} - x_{\text{adp}}^i, \quad (15)$$

where  $i$  is the current iteration of the decision-making process and  $l$  is the iteration number such that  $\Delta x_{\text{correct}} = 0$ .



This is translated into a sequence of adaptations starting by adapting as much as possible in the first adaptation option of the valid hierarchy update control vector  $p_{hv}^{k;i,\dots,v}$  until finally, the disturbance is fully nullified.



## 3 Validation, Results, and Discussion

---

The methodology designed in this work can assure a reliable and cost-efficient control of the operation. The tests are performed by simulating an environment that mimics the behavior of a real water distribution network through software modeling techniques. This enables the extraction of results that can be extrapolated to real WDN. The results are compared with other controllers to provide information about the performance of the adaptive controller across a set of relevant criteria.

### 3.1 Implementation

Two example networks are used to implement the controller and analyses its performance. The first case study applies the adaptive controller in an elementary network composed of a tank and pump. The second case study uses a simplified version of the benchmark Richmond network, which is composed of 7 pumps and 6 tanks.

#### 3.1.1 Simulation Framework

As explained in the methodology, the adaptive controller is composed of three modules. For simulation purposes, each module has to be modeled through software. The adaptive scheme module and the controller module are the algorithms developed in the methodology. The network module must be represented virtually by shaping the environment of a real network.

The subsystem F is an excellent framework to test new ideas given its simplicity. The results for this case-study mainly help understand and validate the methodology, not necessary to extrapolate the methodology to real-world scenarios. The scheme of the first network is represented in figure 12 [26]. Since the system is relatively simple, the hydraulic model was implemented using Python. For simulation purposes, and since the adaptive scheme uses a prediction of the water consumption of the system, the modeling framework uses two hydraulic models, one to give the “real” readings at every control increment and another to extract a 24-hour prediction and optimal pumping schedule.

The difference between these hydraulic models lies in the parameters of the consumption functions. The “real consumptions” of water have slight deviations according to the type of test performed. The prediction is always extracted from the same consumption curve.

For the second case study, the hydraulic model of the Richmond network was used with the Epanet simulator. The scheme of the system is represented in figure 13. The Richmond network is a very well-studied network in the academic arena, and a valuable benchmark to test new methodologies and ideas. Besides that, given its complexity and approximation to the real-world scenarios, the results are helpful to validate a new dimension of the adaptive controller developed for this work, scalability. In a single pump-tank simulation, the relation is very straightforward and easy to explore. In a complex network, the interdependence between the several nodes and links might become the bottlenecks of the operation and the reason for failure. Therefore, this case-study provides better conditions to validate the new methodology.

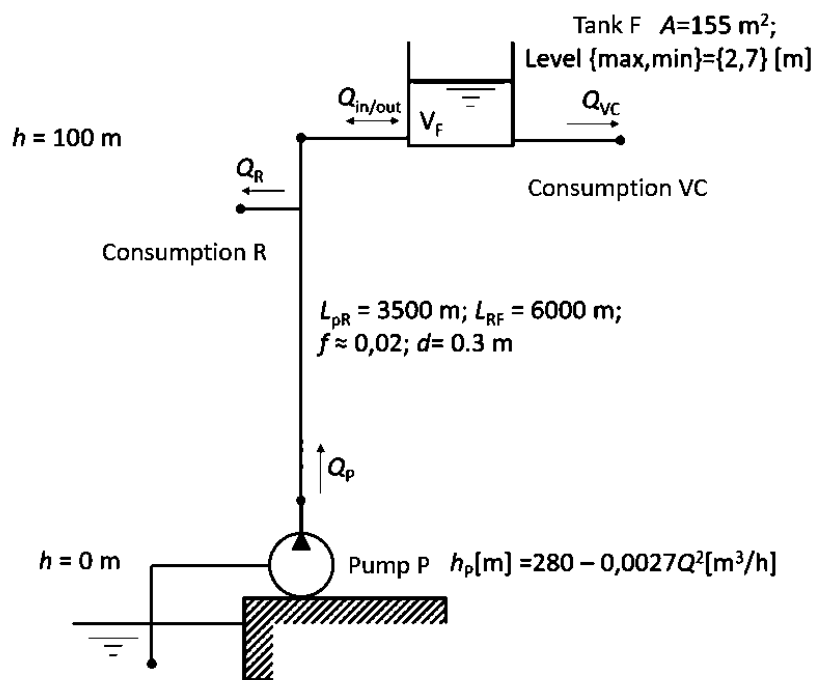

Fig. 12 – Subsystem F network scheme [26].

The case study 2 uses the capabilities of the Epanet 2.0 software to simulate the environment of this network as virtual real network. The network module interacts with the adaptive controller designed in python through a specific API. Similarly, to the previous case study, the simulation uses the same hydraulic model to extract the forecasted consumption for the 24-hours, and the “real consumption” at every control increment. The water consumption forecast is always the same, and for this case study a fully optimized pumping schedule is not used, but rather a typical pumping strategy. The measured water consumption depends on the test performed.

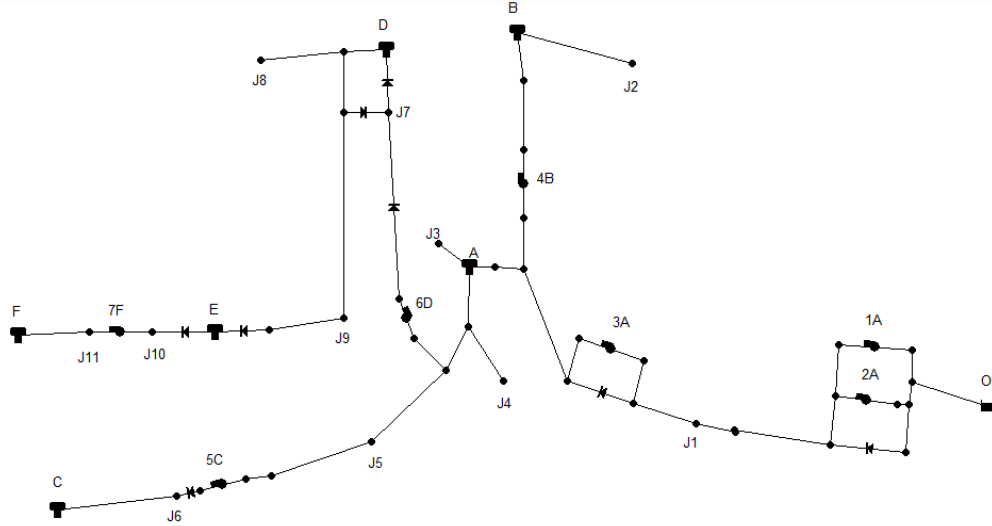

Fig. 13 – Richmond network scheme [11].

### 3.1.2 Evaluation Criteria

To evaluate the model in an objective and standardized way, it's necessary to define clear evaluation criteria. Since the main concerns in a WDN are related to reliability and cost, these are also the main concerns of evaluation, and the most critical metrics for forwarding analysis. The best result delivers the highest reliability at the lowest cost. It is defined success if the adaptive controller can perform better or equally well in these evaluation criteria than the standard controllers.

The reliability is measured by the number of times the controller manages to control the water level of the tank throughout the whole day. This means, that the water level must stay within the established limits. In the case of the subsystem F, between 2 and 7 meters. For the Richmond network, the limits vary for each tank. Any small violation of these constraints is counted as an unsuccessful control. This is indicated by the following equation,

$$\mathbf{sucesses}^{i, \dots, N_t} = \left\{ \begin{array}{l} 1 \text{ for } h_{\text{mim}} \leq y_{\text{est}}^{nInc; k, \dots, nInc} \leq h_{\text{max}} \\ 0 \text{ for } h_{\text{mim}} \geq y_{\text{est}}^{nInc; k, \dots, nInc} \geq h_{\text{max}} \end{array} \right\}, \quad (16)$$

where the vector  $\mathbf{sucesses}^{i, \dots, N_t}$  holds the success history of the simulations based on the test condition presented,  $i$  is the the current test, and  $N_t$  is the number of tests performed. With this information it's possible to calculate the success rate  $S_{\text{rate}}$  of each example as demonstrated by,

$$S_{\text{rate}} = \frac{\text{sum}(\text{sucesses})}{N_t} \times 100 (\%). \quad (17)$$

For subsystem F, this evaluation is made for  $N_t = 1000$  simulations in each test, and the result comes over the form of a percentage that indicates the frequency of the successful controls. If the result is  $S_{\text{rate}} = 100\%$ , it means the controller managed to control the water level within the established limits in every simulation of a specific test. Conversely  $S_{\text{rate}} = 0\%$ , it means the controller failed at holding the water level within the safe limits. For the Richmond network, this criterion is weighted in the cost of the control since the software Epanet 2.0 as inbuilt systems that prevent the failure of the water level by automatically increasing the amount of pumping time.

For subsystem F, the cost is measured by the average cost taken from all simulations, for each of the test condition. For the Richmond network, the cost is measured for each of the executed simulations.

The tested controllers aim at replicating the typical methodologies used in order to establish faithful comparisons with the controller developed for this project. This way, it's possible to understand the performance of the designed controllers when compared with the existing standard methodologies and make a standard analyzes on the results. The controllers are the following;

- 1) Regular feedback controller – A control strategy focused on keeping the water level within a given level;
- 2) Optimal strategy controller – A control strategy based on the prediction of water consumption;
- 3) Adaptive controller – This is the controller designed for this project.

The subsystem F uses all the controllers to compare results. The Richmond network, however, only uses the controller 2 and 3 due to limitations with the modeling techniques. While the controller 2 in the subsystem F case study doesn't suffer any sort of adaptation by monitoring the real water consumption, the controller 2 in the Richmond network suffer automatic adjustments made by the software Epanet 2.0.

### 3.1.3 Type of Tests

Different tests are performed to study the adaptive controller response to various situations, are introduced by using different water consumptions of the "real network." These water consumptions are created by adding different types of noise with a distinct bias to the initially forecasted water consumption. Note that each test, although it represents the same water consumption deviation

pattern, it practically shows different consumptions at every simulation. This procedure allows to extract robust conclusions from the results.

The criteria to choose the tests resulted from informed discussions with experts in the water industry that highlighted their biggest concerns and which features add the most value concerning the practical day to day issues found in the operation of water distribution network. These tests were also extracted from compiling the typical concerns found in the literature, like how to deal with a fire situation [25].

Figures from 14 to 24 illustrates the consumptions patterns for each of the tests performed, and these are illustrated in table 3. The blue line in the water consumption graphs is the predicted consumption, and the black dots dictates the real consumption at each increment.

Table 2 – Type of test performed to evaluate the performance of the adaptive controller

NUMBER	TEST	PURPOSE
1	Average consumption bias	This test allow to analyze the response of the controller under average noise conditions. The test is only performed for the subsystem F case study.
2	Overconsumption bias	In this test it's analyzed if the controller can effectively deal with the constant increase in water demand
3	Underconsumption bias	This test allows to analyze if the controller can effectively deal with the constant decrease in water demand.
4	Average consumption with noise bias	This test allow to analyze if the controller can deal with the consumption curves that have a high degree of variability when compared with the prediction.
5	Higher over consumption bias	This test allows to evaluate the magnitude effect in the deviation and help understand how this magnitude impacts the controller response.
6	Fire Situation	This test allow to analyze the robustness of the controller to unpredictable peaks in demand such as the ones observed in a fire situation.
7	Missing data with average consumption bias	This test allows to analyze the behavior of the controller in situations where the central server stops receiving data from the network.



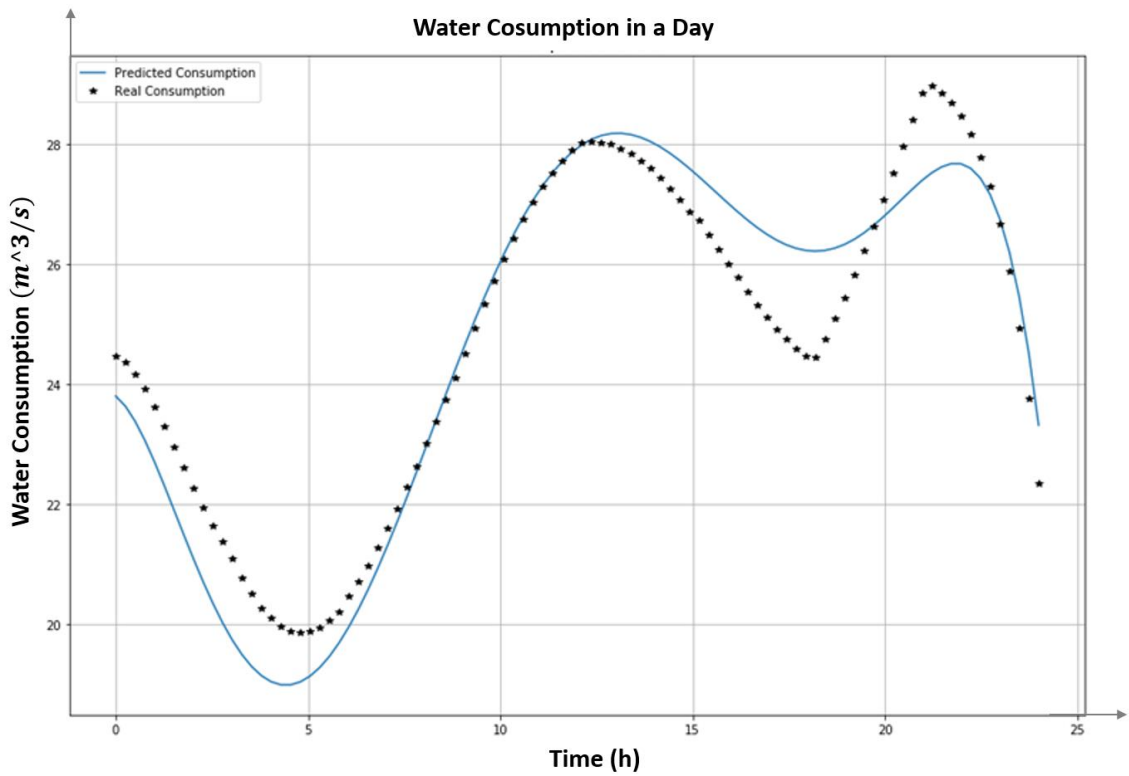

Fig. 14 – Average water consumption bias for the subsystem F network, test 1.

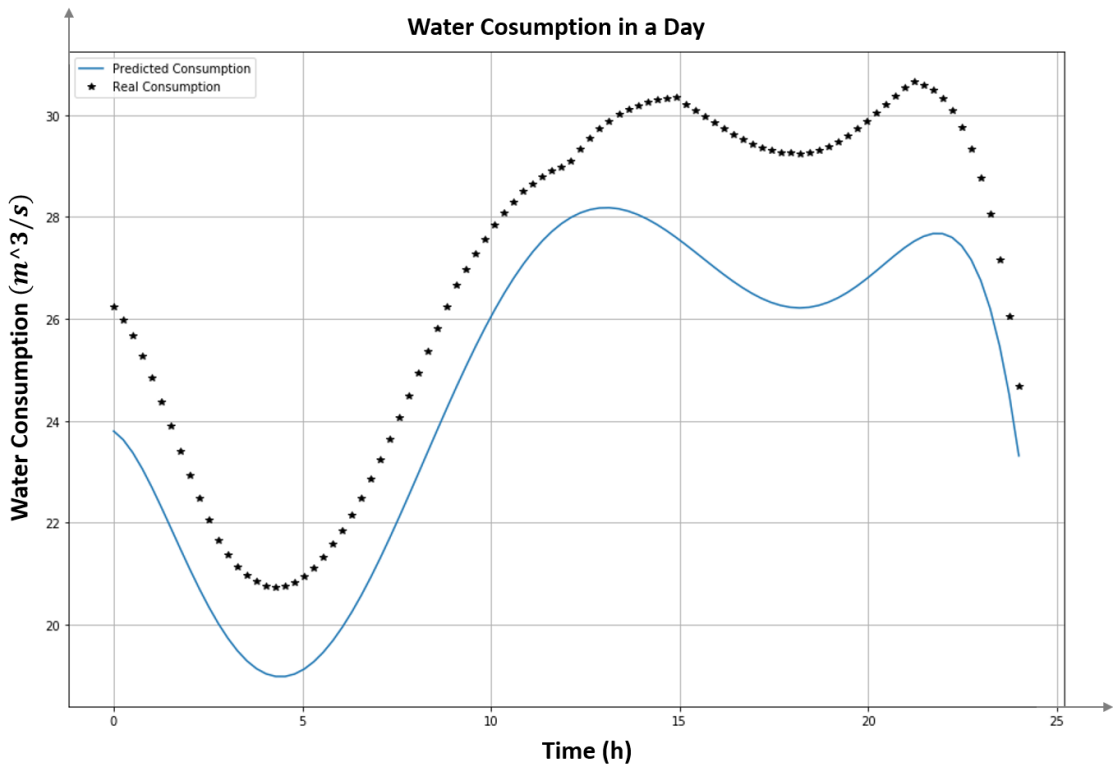

Fig.15 - Water consumption for over biased deviation in subsystem F, test2.

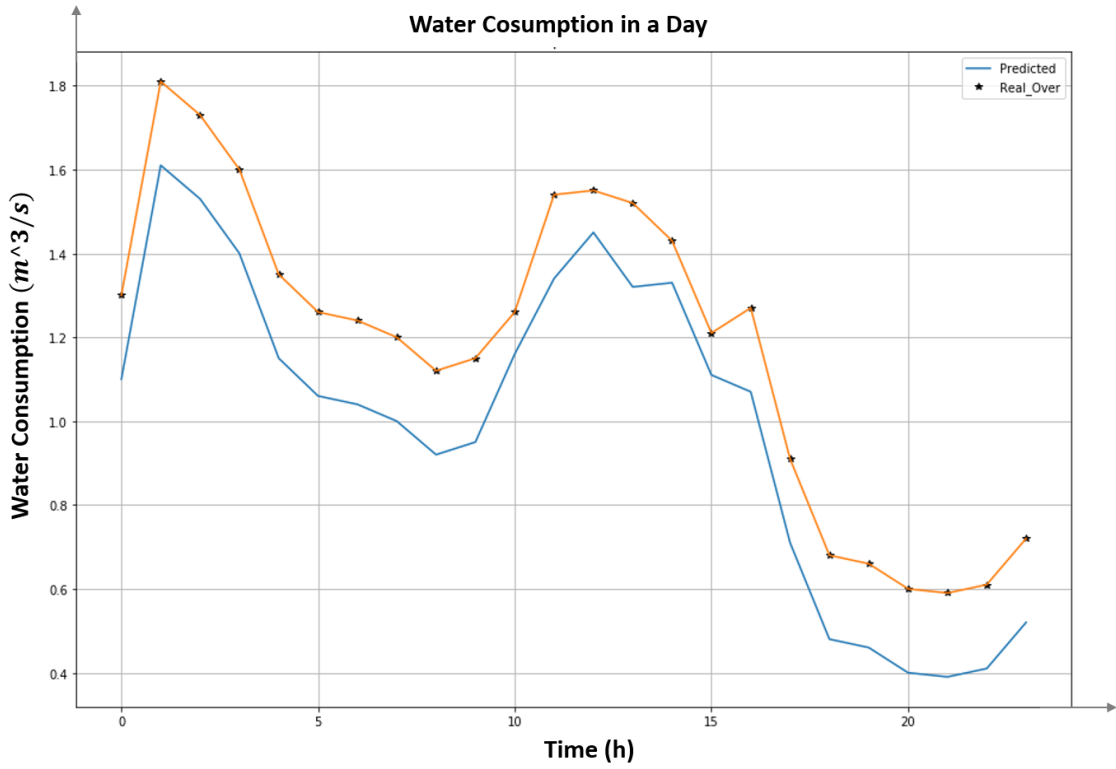

Fig. 16 - Water consumption for over biased deviation in Richmond network, test 2.

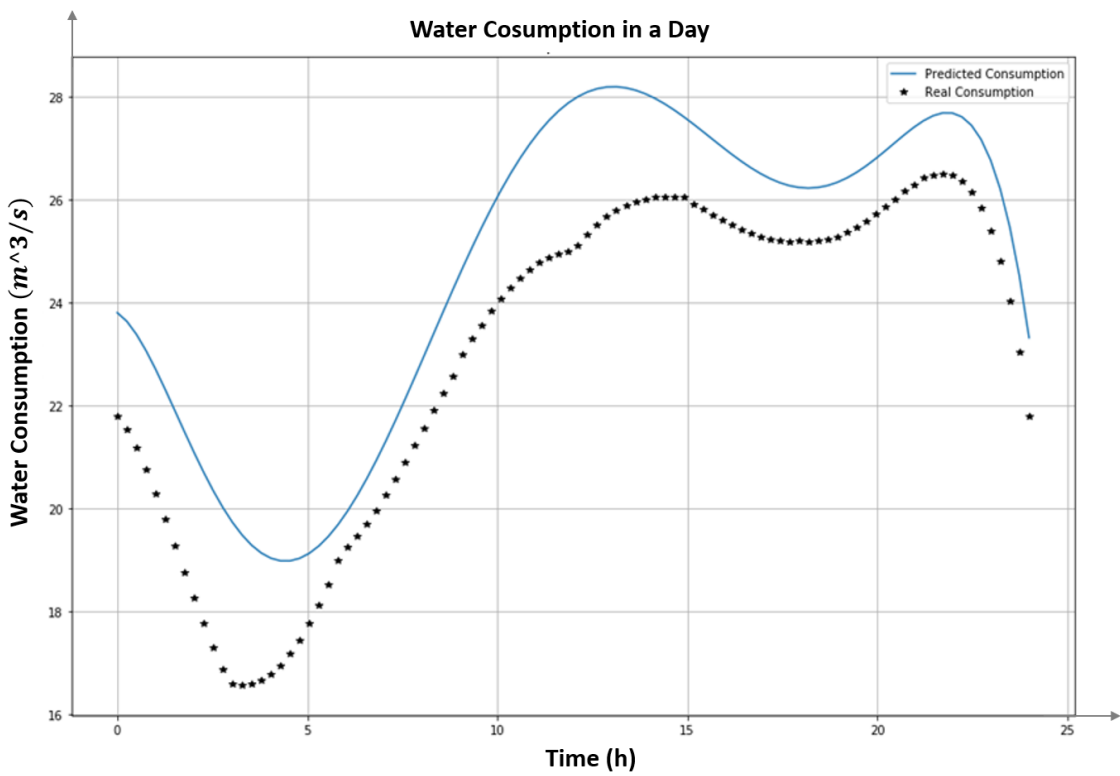

Fig. 17 - Water consumption for lower biased deviation for the subsystem F, test 3.

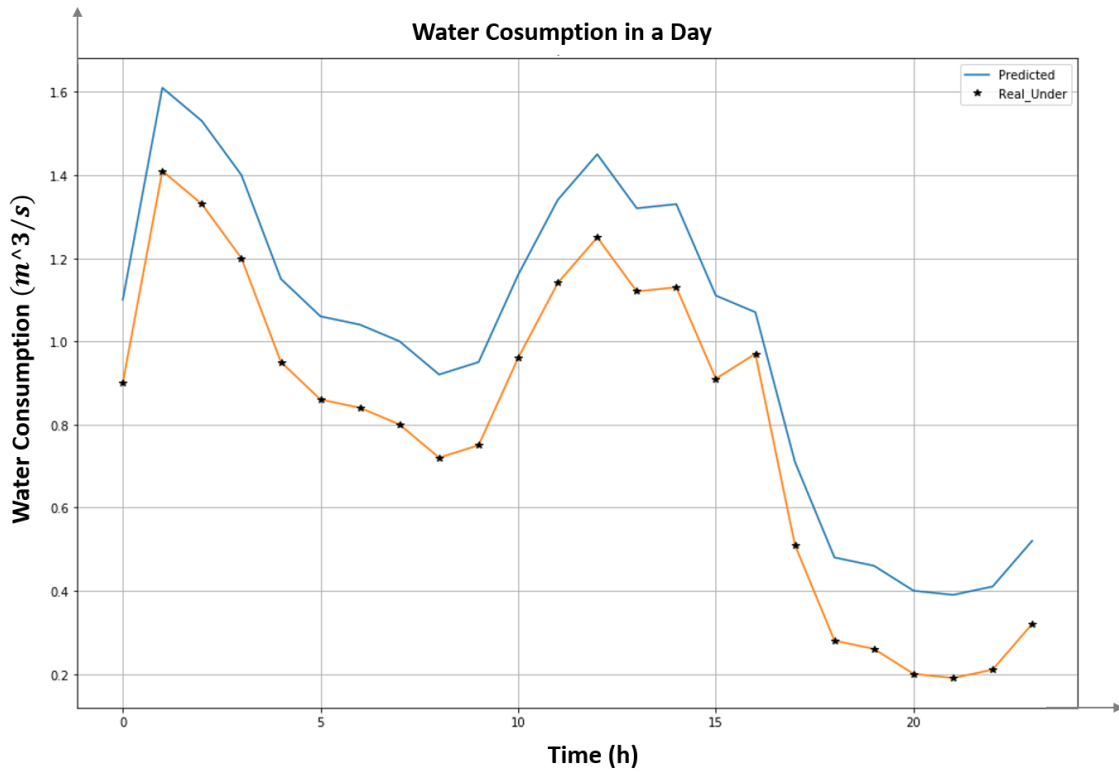

Fig. 18 - Water consumption for lower biased deviation for the Richmond network, test 3.

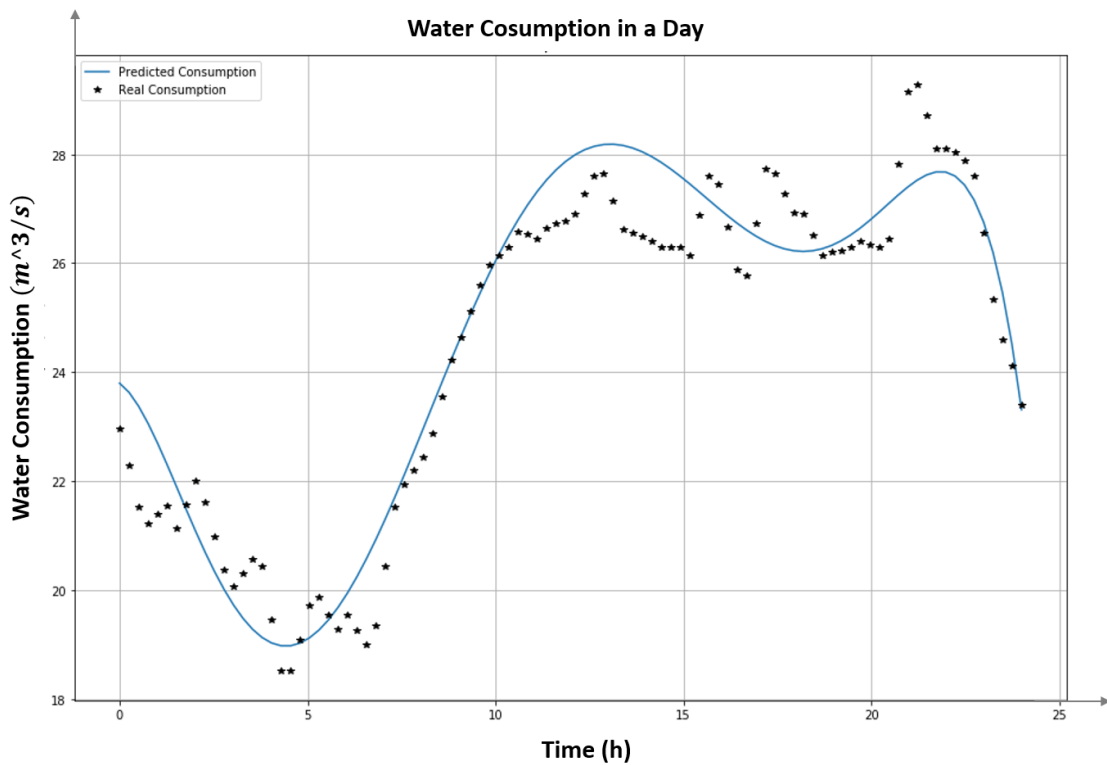

Fig. 19 - Water consumption for noisy averaged biased deviation for the subsystem F, test 4.

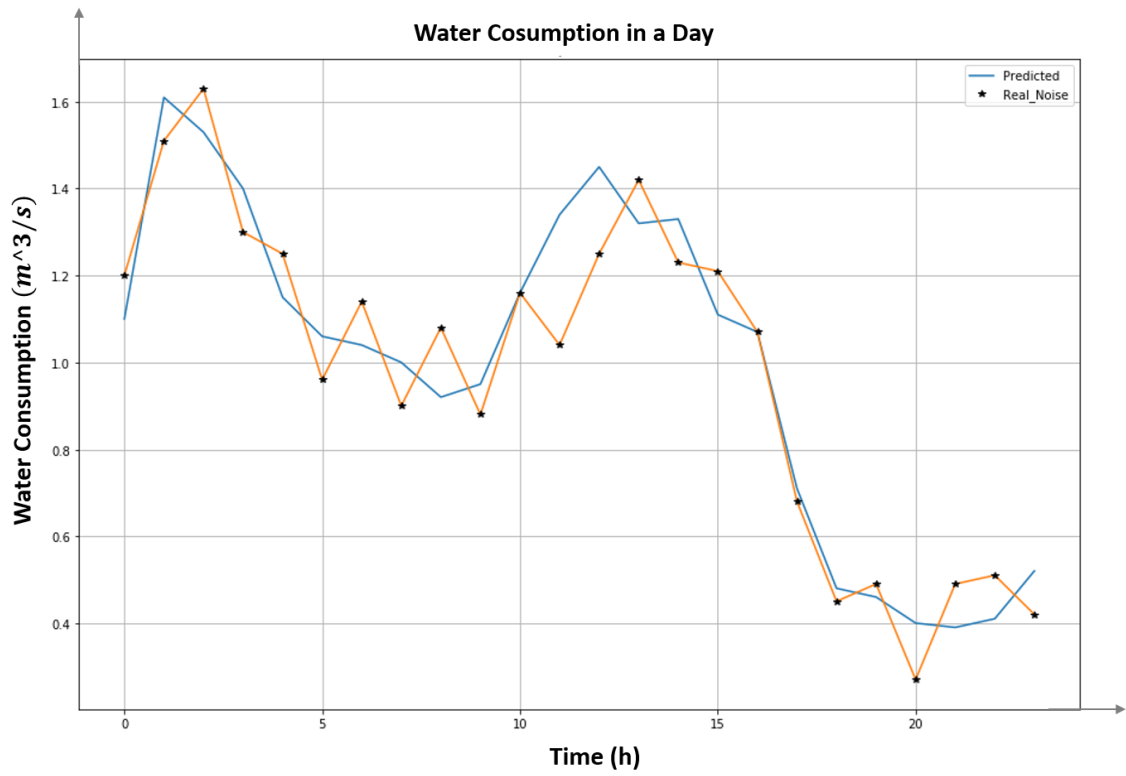

Fig. 20 - Water consumption for noisy averaged biased deviation for the Richmond network, test 4.

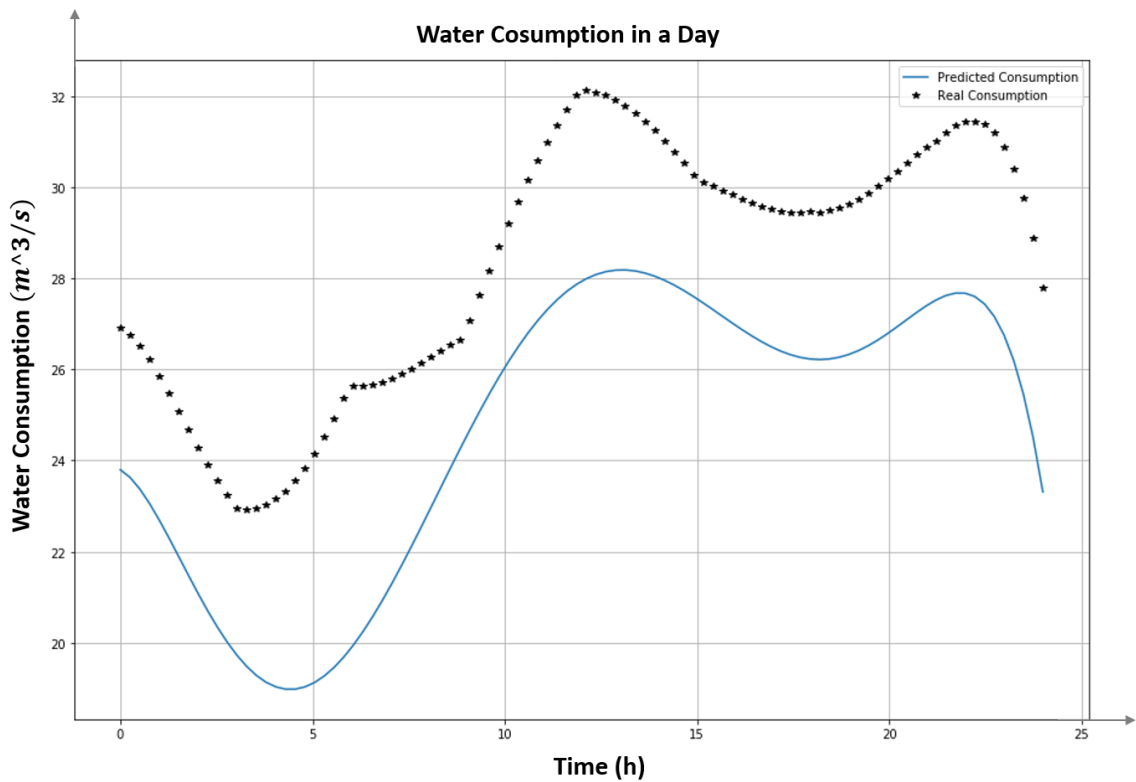

Fig. 21 - Water consumption for higher over biased deviation in subsystem F, test 5.

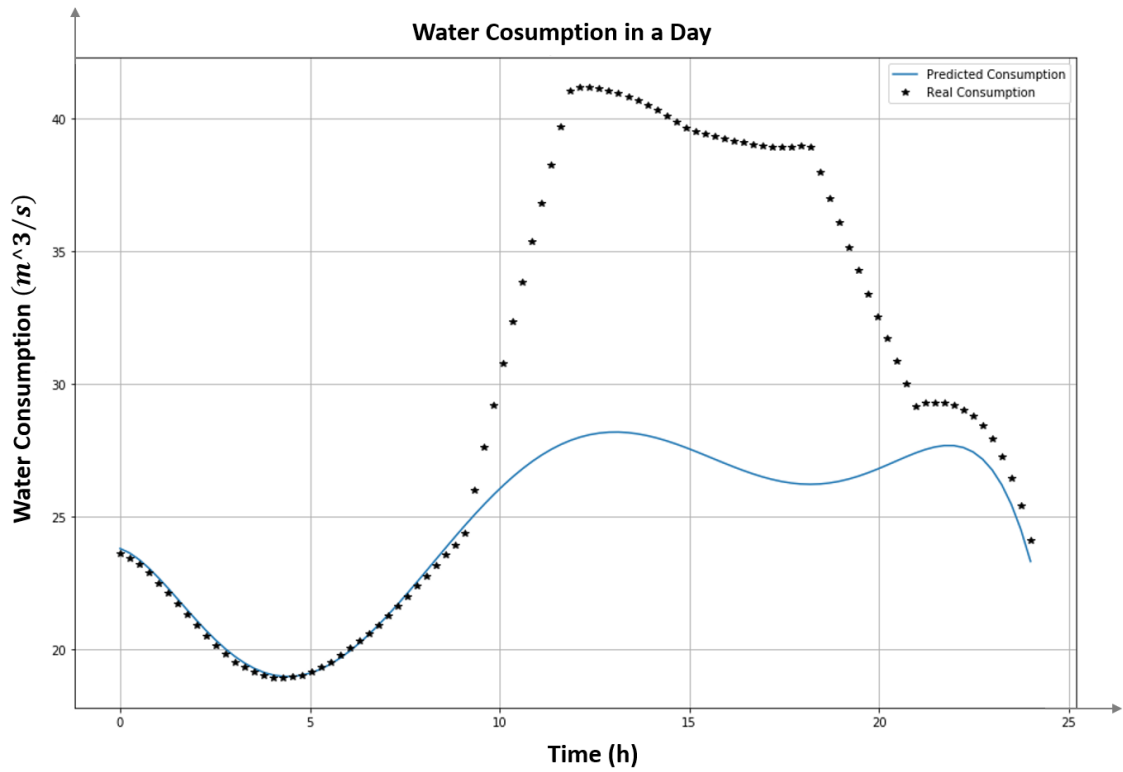

Fig. 22 - Water consumption for fire situation with average biased deviation in subsystem F, test 6.

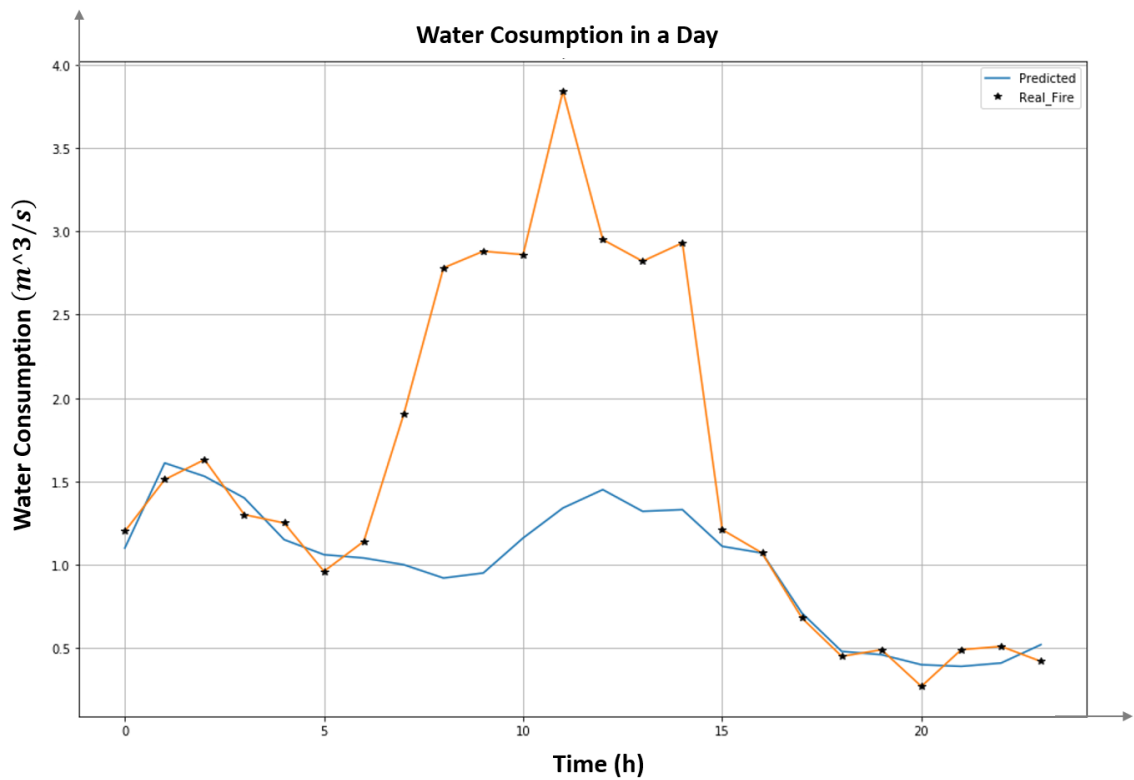

Fig. 23 - Water consumption for fire situation with average biased deviation in Richmond network, test 6.

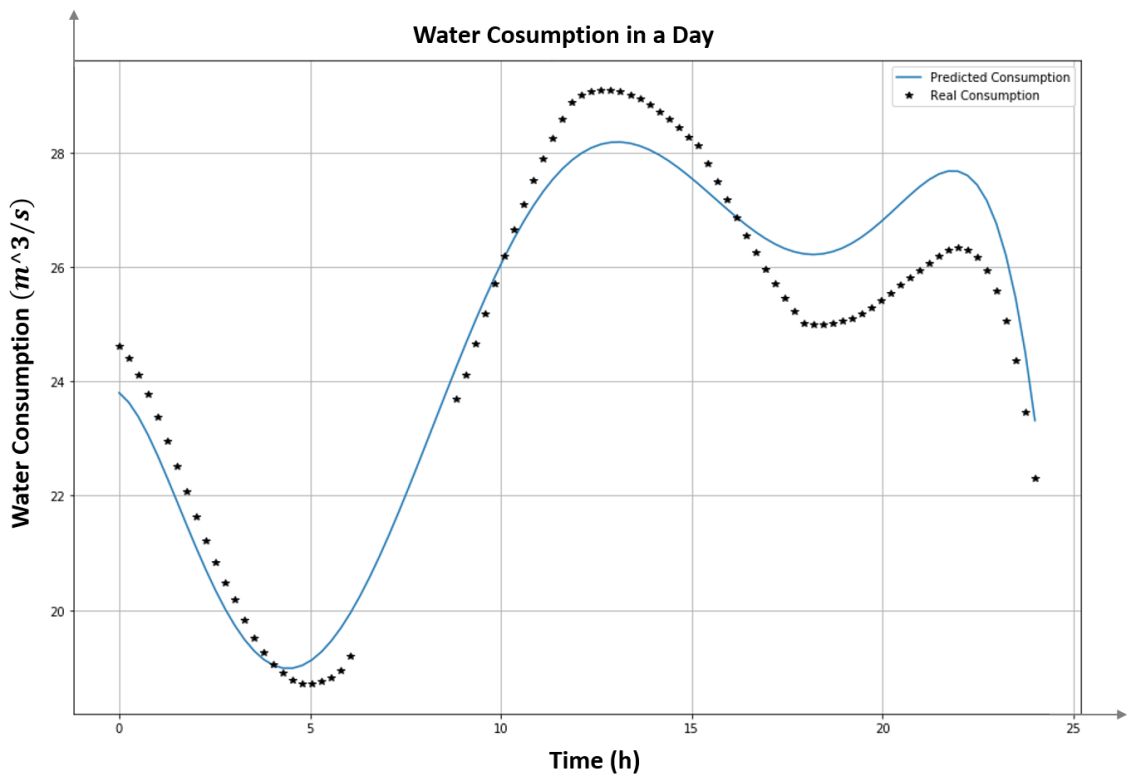

Fig. 24 - Water consumption for average biased deviation with missing data for the subsystem F, test 7.

### 3.1.4 Requirements Process

The constraints of the network are safety limits defined by the operational manager and depend on the characteristics of the WDN. For subsystem F, as mentioned, the constraint of the tank are 2 and 7 meters. For the Richmond network, the limits are described in table 4.

Table 3 – Constraints for the tanks of the Richmond network.

TANK X	MIN	MAX
A	0	3,37
B	0	3,65
C	0	2
D	0	2,11
D	0	2,69
F	0	2,19

For the implementation of the adaptive controller it's necessary to perform a sensitivity analysis. As explained in subsection 2.2.2 this analysis is performed to determine the linear relationship between the increasing of pumping time and

the water level in the tank. Figure 25 shows the result of the linear regression performed, where the results gave  $m = 1,27$ . Therefore, for an increase of 0.1 hours of pumping time, it's reflected 0.127 meters increase of water level in the tank.

The same process is applied for each of the pumps and tanks relations for the Richmond network. It's defined a tank and pumping relation when these elements are found in series in the network. Table 4 indicates all of these relations. As it can be noticed the relations are different across most of the network pumps and tanks.

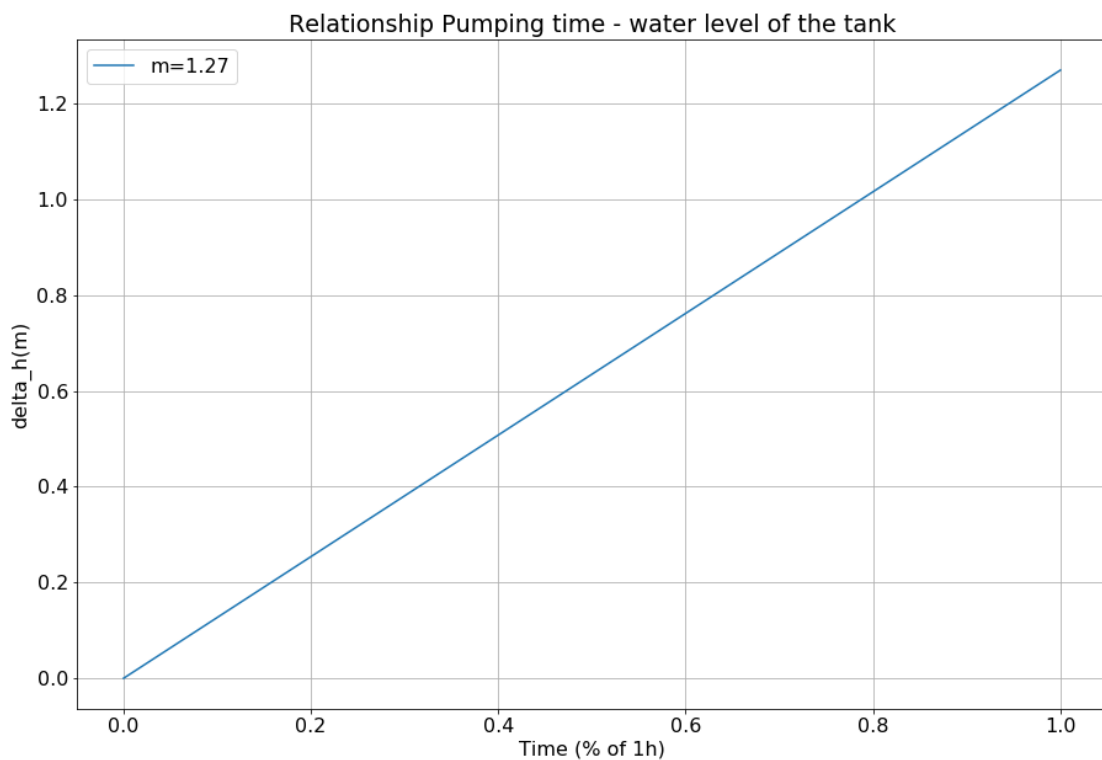

Fig. 25 – Linear relation between pumping time and water level of the tank for subsystem F

This information establishes the connection between the variable of control and the response of the network. This is a necessary insight to determine the adaptations of the adaptive scheme module. The tariffs corresponding to each pumping depend on the location of the network. An example is demonstrated in table 1 of subsection 2.2.1.

The constraints, the pump-tank relationship, and the tariffs of electricity are dependent of the network. Therefore, these parameters must be studied and formalized before proceeding to the application of the adaptive controller. After determining them through the process described in the methodology, these must be built into the adaptive scheme.

Table 4 – Constant Pump-Tank relations for the Richmond network

PUMPING X TO TANK X	PUMP-TANK CONSTANT RELATION (M/HOUR.PUMPING)
A-A (3 SINCRONIZED)	0.3
B-B	0.3
C-C	0.12
D-D	0.3
D-E	0.25
F-F	0.4



## 3.2 Results and Discussion

### 3.2.1 Subsystem F

The following points highlight the results for each of the tests. The bar charts show the compiled information of the 1000 simulations concerning the cost and reliability. The first bar is the result for the regular controller, the second bar is the optimal strategy controller, and the last bar is the designed controller for this project.

Figures c represent 1 simulation of the performed 1000 and indicate the water level over the 24-hour period and figure d shows the fraction of pumping time over the 24-hour period. This helps understand the typical control pattern achieved for each one of the controllers. The blue line is referring to the behavior of the regular controller, the yellow line to the optimal strategy controller, and the green line to the adaptive controller. Note that for these simulations, it's used  $nInc = 96$ , which means that a control cycle is performed every 15 minutes.

From this point forward, the regular controller is addressed as control A, the initial optimal strategy control as control B, and the designed controller for this project as control C.

#### 1. Average consumption bias test

As can be seen from figure 26 the reliability of the controller A is 100%, meaning that successfully controlled the water level in every simulation. The controller B is only successful at controlling the water level 8.7% of the times, although as it can be seen by the water level curve in figure 26, the constraints are violated only slightly. The controller C manages to control the water level of the tank in 92.6% of the simulations. The controller A far exceeds the cost of the other controllers, being the controller B the most optimal cost followed by the controller C. Note that the increase in cost for control C when compared with the control B results in a rise in the level of water at the end of the day. The same can be observed for control A even though the magnitude is entirely different.

Note that the unreliability of control B is due to the fact that, in its simulation, there is no additional control besides the initial instructions. In reality, this would not happen since an operator would receive an alarm, and counter measures are taken to avoid that situation. Nevertheless, this is useful to understand that optimized instructions are not very successful at automatically and independently controlling the network.

## **2. Overconsumption bias test**

From figure 27, it can be observed that controller A and C both achieved 100% reliability, while controller B failed to control at every simulation. For the same reason stated previously, controller B can't make the control simple by following the forecasted pumping instructions, especially in a situation where the real consumption is consistently higher.

The cost of control is highest for controller A, followed by controller C and lowest for controller B. Again, note that this increase in cost is reflected by more water in the tank. Therefore, this marginal increase of cost for the controller C compared with controller B is not necessarily a sign of a more expensive control but rather the result of the necessary adjustments to cope with an increase in consumption. A more faithful comparison can be made with controller A, where the cost is substantially higher at the same reliability success.

The overall results of this test besides proving the ability of the adaptive controller to deal with overconsumption deviations, also prove its efficacy at keeping the cost down while performing adjustments to an increase in water demand.

## **3. Underconsumption bias**

Like the previous test, from figure 28, it can be observed that controller A and C both achieved 100% reliability, while controller B failed to control at every simulation. For the same reason stated before controller B can't make the control simple by following the forecasted pumping instructions, especially in a situation where the real consumption is consistently lower.

Since the demand of water is consistently lower, it's expected that the cost of operation also decreases, it's possible to observe that from figure 28 by comparing the cost of control of controller A and C. Controller B didn't improve its cost efficiency, since there is no adaptation to demand, the cost remains the same.

## **4. Noisy average consumption bias**

The consumption bias for this test is similar to the first test, however, it's introduced more noise. From figure 29 it can be seen that the reliability of the controller A is 100% and for controller C 91.6%, the controller B comes in last with the worst performance of 8.3% reliability.

Figure 29 shows that the cost is highest for control A, then B and finally C. Note again that the increase in price is accompanied by more water in the tank. The results for this test are similar to the ones observed in test 1, indicating that the adaptive controller is robust to noisy deviations.

## **5. Higher over consumption bias**

This test is similar to test 2 but at a different magnitude, the deviation is consistently higher than the forecast and at higher magnitude. The results are also relatively similar to test 2, differing only on the magnitude of the cost for control A and C as observed in figure 30. Figure 30 also shows that the controller A and C managed to reliably control the operation in every simulation. Figure 30 shows an alarming situation for control B, revealing the possibility of not having water in the tank if the optimal strategy is followed diligently.

## **6. Fire situation**

This test aimed at understanding if the constraints validation idea was capable to deal with unexpected increase in demand, such as a fire situation. Figure 31 shows that controller A was 100% reliable at dealing with this situation, while controller C reached a reliability of 72%. As expected, controller B didn't succeed in controlling the operation in any simulation.

Due to an abrupt increase in demand, the costs of operation increased for controller A and C, however the increase in cost for controller C was much lower than A when comparing with the test 1. This is an indication of the ability of the adaptive controller at finding the most cost-efficient adaptation to cope with deviations, even in such disrupting conditions.

## **7. Average consumption with missing data**

To understand the ability of the controller to operate when it's not receiving data from the network of test 1 is simulated using average consumption bias deviation with random periods of missing data. The methodology predicts that this is not problematic since the controller simply doesn't adapt and operates following the most recent control model.

Figure 32 shows that controller A and C obtained similar reliability results in comparison to test 1. The same can be observed in figure 32 relatively to the cost of operation. This is clear evidence that the adaptive controller is very robust at dealing with situations where it misses information for a period of time.

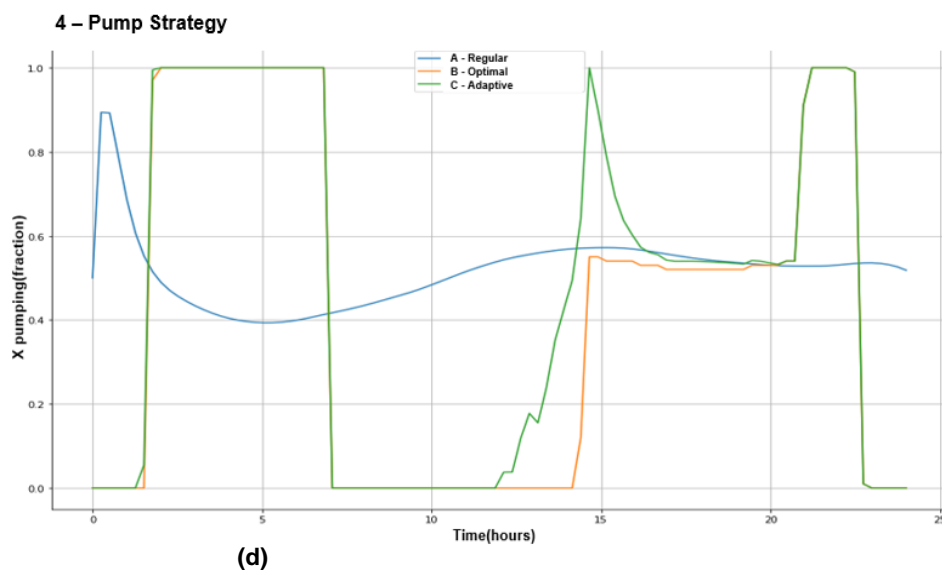
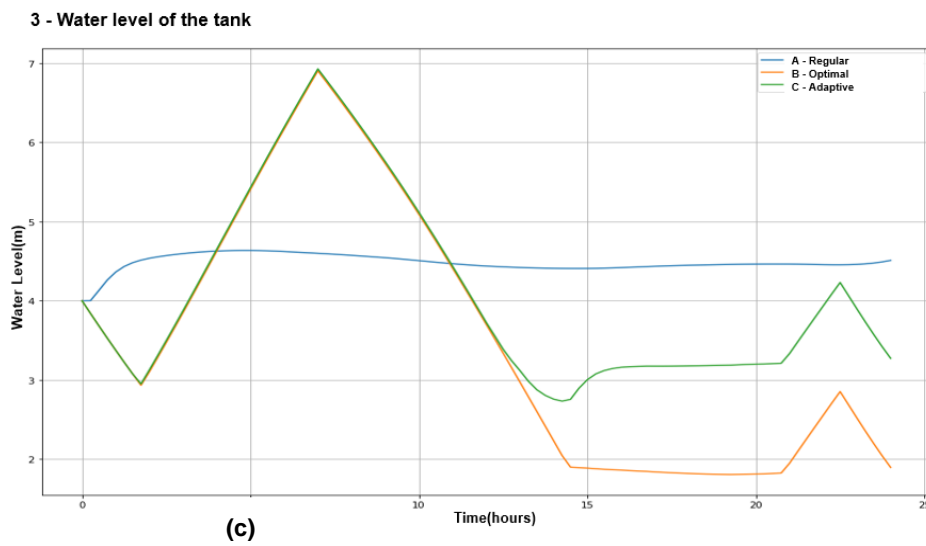
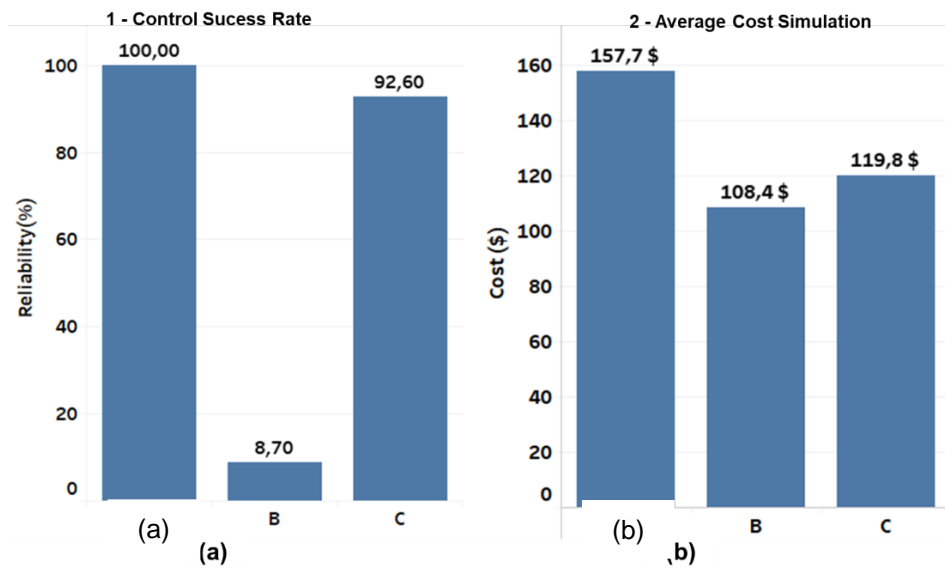

Fig. 26 – Results for average consumption bias test: (a) chart that represent the reliability success of each controller, (b) chart that represent the average cost for each control method, (c) Water level of the tank for each control method, (d) Pumping strategy for each control method.

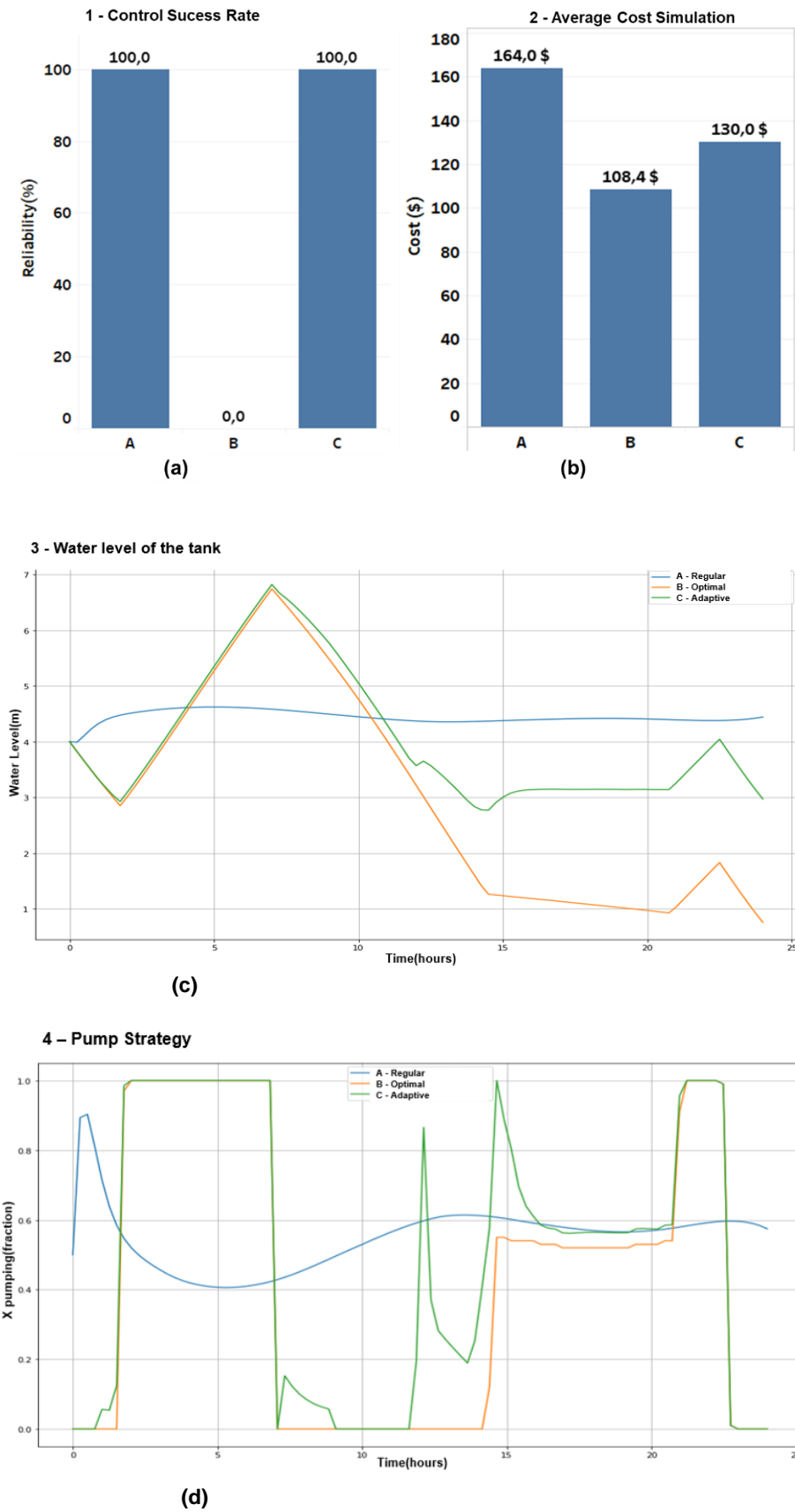

Fig. 27 – Results for overconsumption bias test: (a) chart that represent the reliability success of each controller, (b) chart that represent the average cost for each control method, (c) Water level of the tank for each control method, (d) Pumping strategy for each control method.

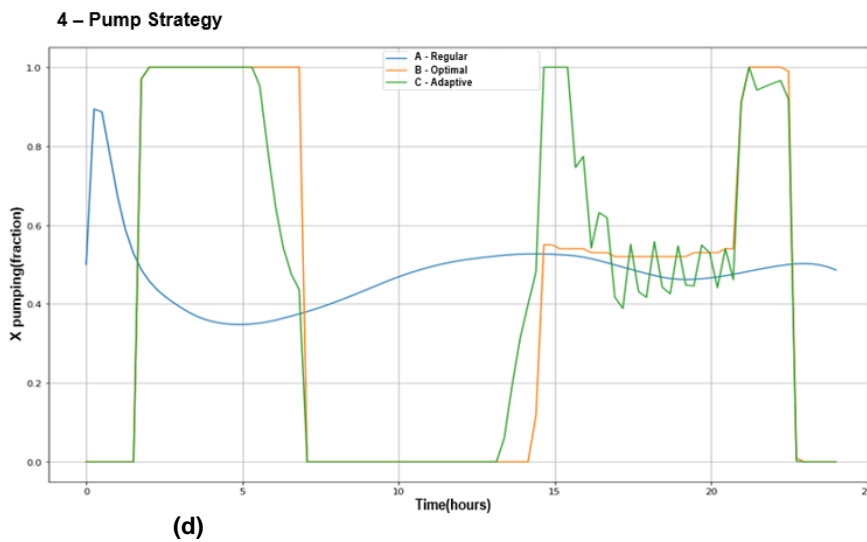
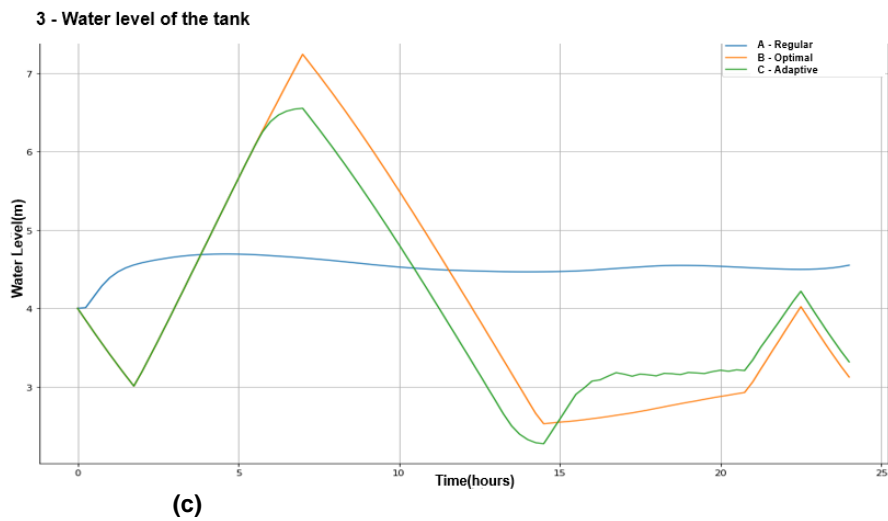
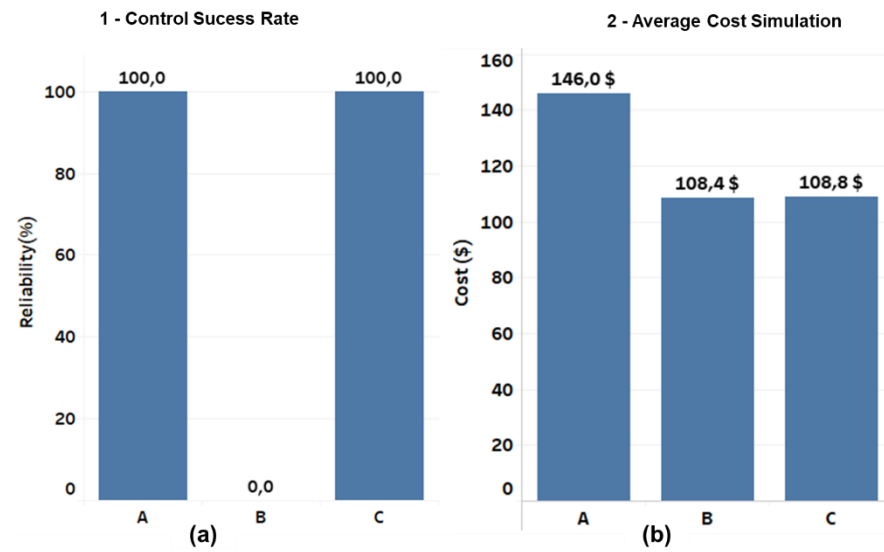

Fig. 28 – Results for underconsumption bias test: (a) chart that represent the reliability success of each controller, (b) chart that represent the average cost for each control method, (c) Water level of the tank for each control method, (d) Pumping strategy for each control method.

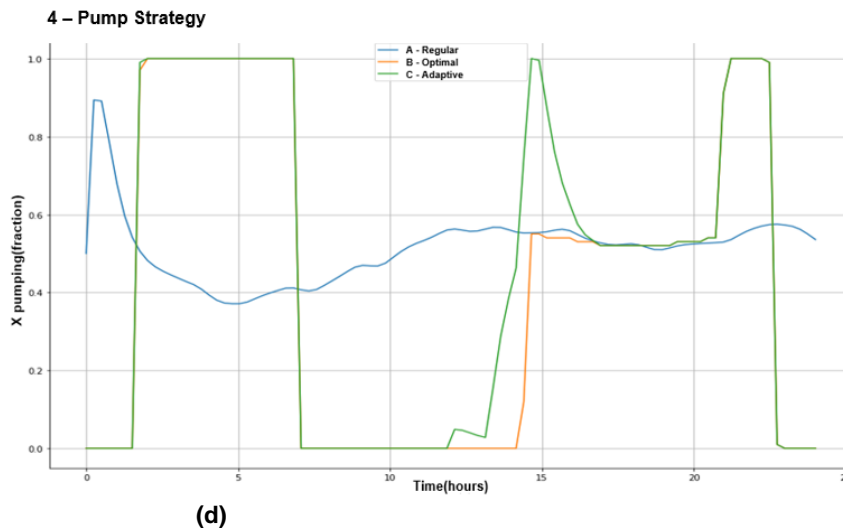
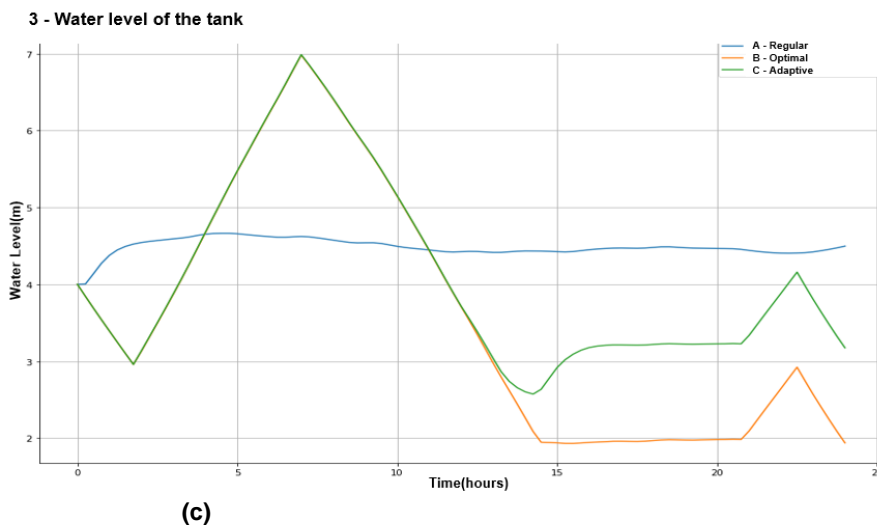
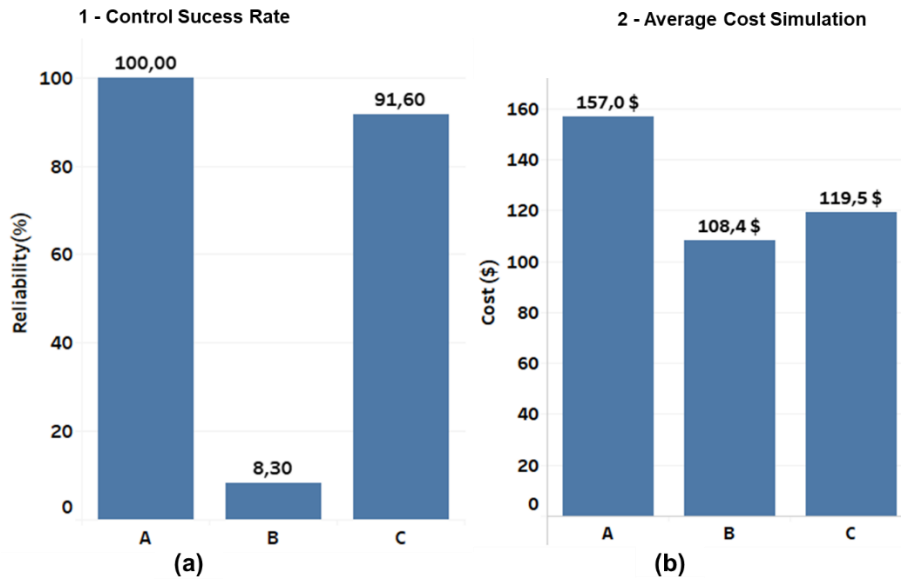

Fig. 29 – Results for noisy average consumption bias test: (a) chart that represent the reliability success of each controller, (b) chart that represent the average cost for each control method, (c) Water level of the tank for each control method, (d) Pumping strategy for each control method.

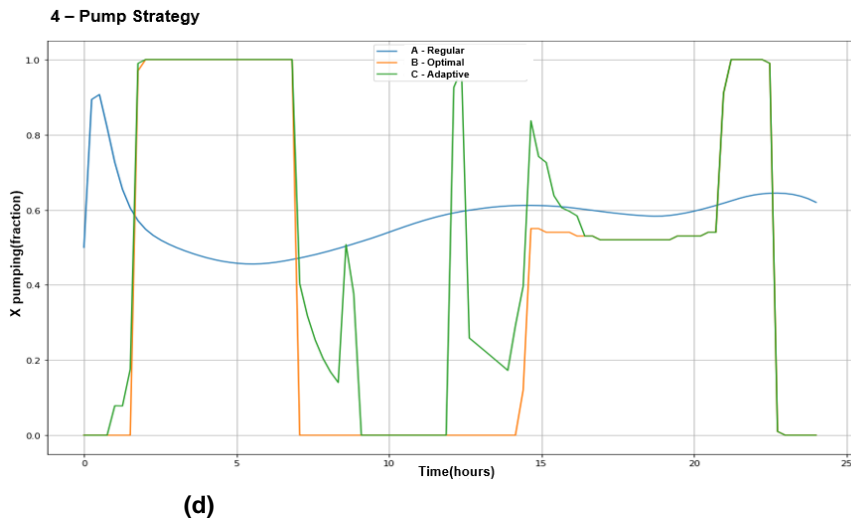
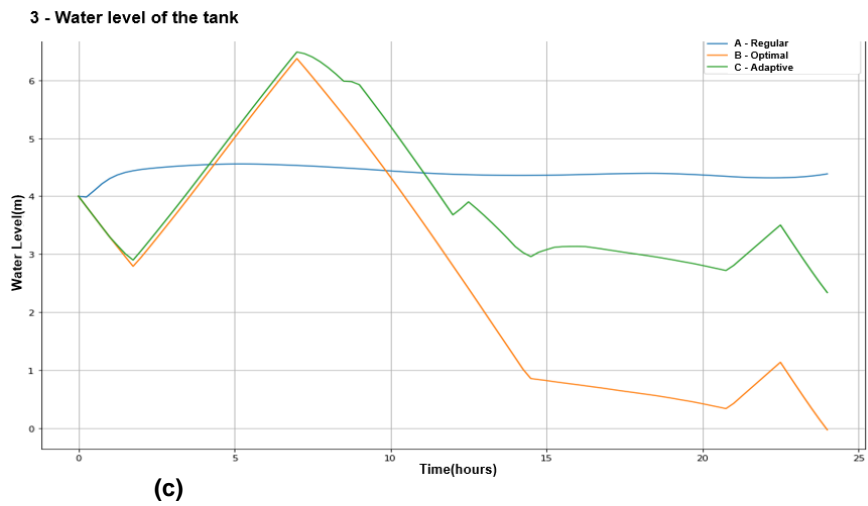
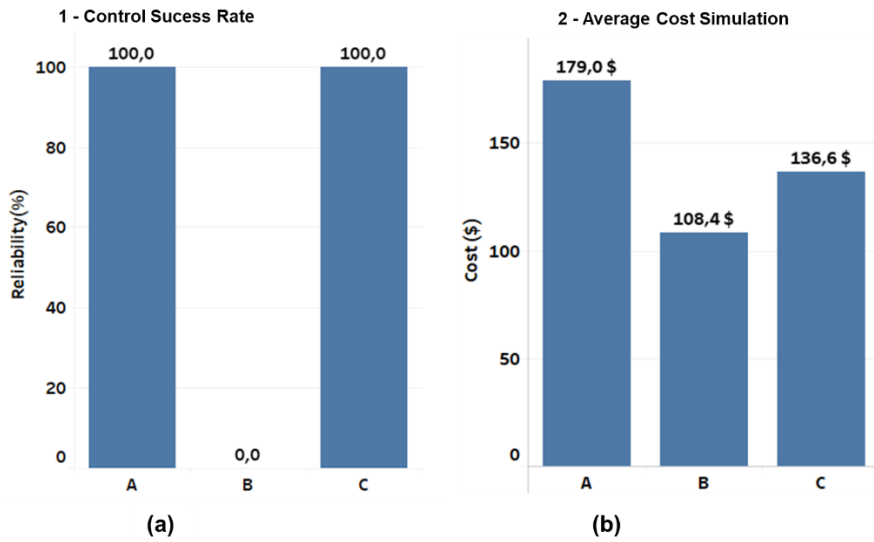



Fig. 30 – Results for higher overconsumption bias test: (a) chart that represent the reliability success of each controller, (b) chart that represent the average cost for each control method, (c) Water level of the tank for each control method, (d) Pumping strategy for each control method.

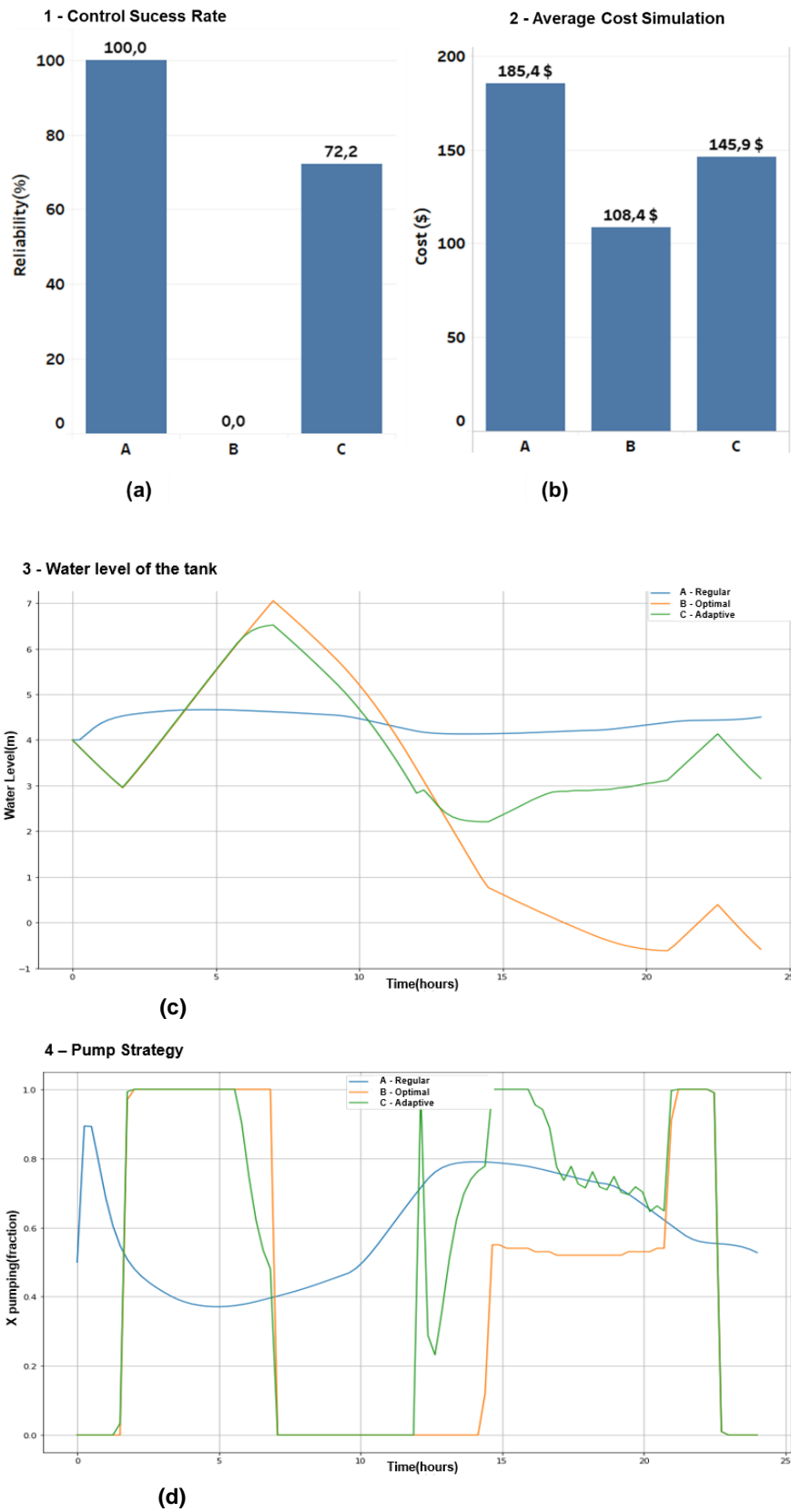

Fig. 31 – Results for Fire situation with average consumption bias test: (a) chart that represent the reliability success of each controller, (b) chart that represent the average cost for each control method, (c) Water level of the tank for each control method, (d) Pumping strategy for each control method.

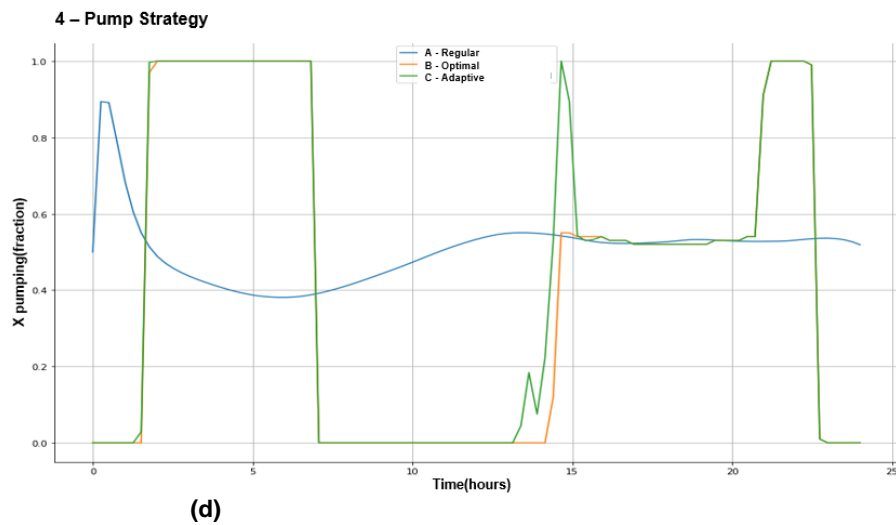
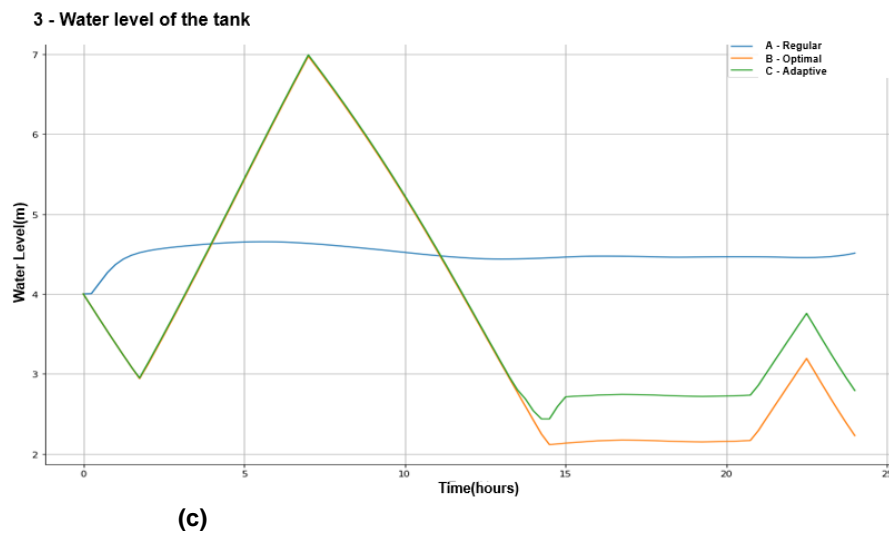
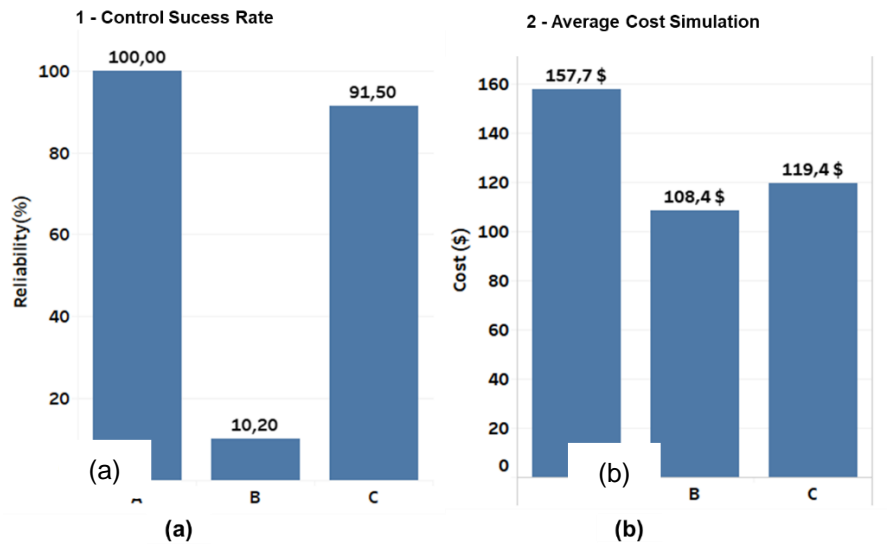

Fig. 32 – Results for missing data situation with average consumption bias test: (a) chart that represent the reliability success of each controller, (b) chart that represent the average cost for each control method, (c) Water level of the tank for each control method, (d) Pumping strategy for each control method.

The adaptive controller has proved to deliver positive results in efficiently controlling the WDN, however, it's necessary to fit these results into the simulation limitations and real-world implications to make a fair evaluation.

Across every test the adaptive controller has performed substantially better than the optimal controller in terms of reliability, but it's not meaningful to say that this methodology is unreliable, for two simple reasons; (i) the simulation doesn't consider the typical real-world scenario, where there is a combination of operators combined with data visualization to prevent these situations. (ii) this case study, in particular, is not the best example of an optimal strategy for a WDN since the optimization was too extensively explored to the point that facilitates the violation of constraints. Therefore, it's not possible to make a direct comparison of reliability between the adaptive controller and the optimal controller.

What this proves is that the adaptive controller can reliably deliver cost-efficient results in a fully automatic operation without operator intervention. Across the different tests, the least reliable simulation is the one that aims at replicating a fire situation, which achieves a 72% success rate. This means that even in extreme circumstances, the adaptive controller manages to deliver cost-efficient automatic results, without any sort of intervention.

The cost comparison between the initially optimal and adaptive controllers can't also be directly compared. In a real-world scenario, an operator receives alarms concerning the state of the network and manually effectuates adaptations. These adaptations introduced by the operator may be reflected in an increase in the cost of controlling the network. This would be the comparable cost for this type of controller and not the one displayed by the optimal pumping strategy. The assumptions predict that this manual adaptation might result in a higher cost of operation since it doesn't extensively explore the fluctuations of the tariffs as the adaptive controller has the capacity to do.

The reactive controller is introduced to compare the different automatic strategies. As it can be seen across the different test, the reactive controller flawlessly controls every situation. However, at a much higher cost than the adaptive controller. A good comparison can be made in test 5, where the reliability success rate is the same, for the adaptive controller and the reactive controller, but the latter performed the control at 31.6% higher cost of operation than the adaptive controller. Besides that, it's important to note that a close observation of the failed controls in the adaptive controller shows that the vast majority of unsuccess at validating the constraints are only slight deviations of the limits that wouldn't most likely compromise the network.

Although this case-study doesn't provide enough evidence to firmly state that the adaptive controller is a better methodology to apply in the pumping stations of a WDN, it gives reasonable indications of the possibilities of the adaptive controller. The tests show that the adaptive controller might be a potential reliable automatic controller solution for a WDN that rival the cost efficiency of an optimized pumping strategy but without operator intervention. The cost-efficiency might not be a direct benefit of the implementation of this new methodology. However, it does provide an answer to one of the problems of the emerging water grids technology by delivering a cost-efficient automatic control to the network.

### **3.2.2 Richmond Network**

Unlike the previous case study and as methodology predicts, the adaptive controller does not use a fully optimized reference. The initial pumping strategy introduced is not optimal. Nevertheless, this is an opportunity to find out the performance of the controller with a different initial condition.

The results for the Richmond network are especially valuable to understand the performance of the adaptive controller since it's used a simulation that better closely simulates a real-world scenario. The only metric of evaluation is the cost. To start, it's presented in figure 33 the reference used. This figure shows the water level of the tanks for the forecasted water consumption, along with the cost. This forecast is used as the reference for the adaptive controller and as comparison. The cost of this operation is 15296.4 \$/day.

Unlike the previous case study, it is only presented the results for two control methods: the optimal and the adaptive controls. The optimal control simply follows the forecasted instructions, but unlike the previous case study, in this simulation the system reacts in case the water level of any of the tanks violates the constraints, by switching on the pumps, thus potentially increasing the cost.

For each test, it is presented the cost and the water level of the tanks for both control methods. The costs can be seen in Table 5, and the graphs for both control methods are presented in the figures 34 to 37.

#### **Noisy average consumption**

The average consumption with noise test provides a very realistic scene for a typical control day. From Table 5 it can be interpreted that the cost of operation for the adaptive controller is slightly lower than the reference controller, about 2.5%. The adaptive controller managed to cope with the noisy consumption

pattern while achieving a lower cost of operation. Both controllers accomplished the control of the operation at a lower cost than the reference. From figure 35 it can be observed that both controllers achieved the same results with approximately the same water in the tank at the end of the day.

### **Constant over consumption**

As anticipated, since the water consumption is constantly higher than the forecast, then the controller should in principle increase the cost of operation. That is verified in the adaptive controller that delivers an increase of 1% when compared with the reference as it can be interpreted from Table 5. Strangely the reference controller managed to decrease the cost of operation when compared with the forecast by 10%. A hypothesis is that since the forecast is not optimized the reference control managed to use the hydraulic benefits of higher demand to spend less energy. Figure 36 shows that both control methods finished with a similar amount of water in the tank at the end of the day.

### **Constants under consumption**

For the same reason stated above, it's anticipated that the cost of control is lower since the demand is constantly lower as well. Table 5 demonstrates the cost of operation for the reference controller is higher than the forecast and the adaptive controller is lower than the forecast. The adaptive controller outperformed the reference controller in this test by delivering the same control results, as it can be observed from the water level of the tanks in figure 36, but at an 8.5% reduction in the cost of the operation.

### **Fire situation**

This test is the simulation of a fire situation. As it can be seen from figure 34 the reference controller didn't manage well the rapid increase of the magnitude of the deviation, letting the water level of the tank drop to zero, which unavoidably forced the pumps to go up. This is particularly inconvenient since the pumps are turned on at the highest price period of the tariff. The adaptive controller, however, managed to keep the water level within constraints and achieved the same control results at a much lower cost. From Table 5 it can be seen that the cost of the reference control for this operation is 6 orders of magnitude higher than the adaptive controller. This is due to the fact that the price tariff is 6 times higher in the periods the optimal controller had to adapt.

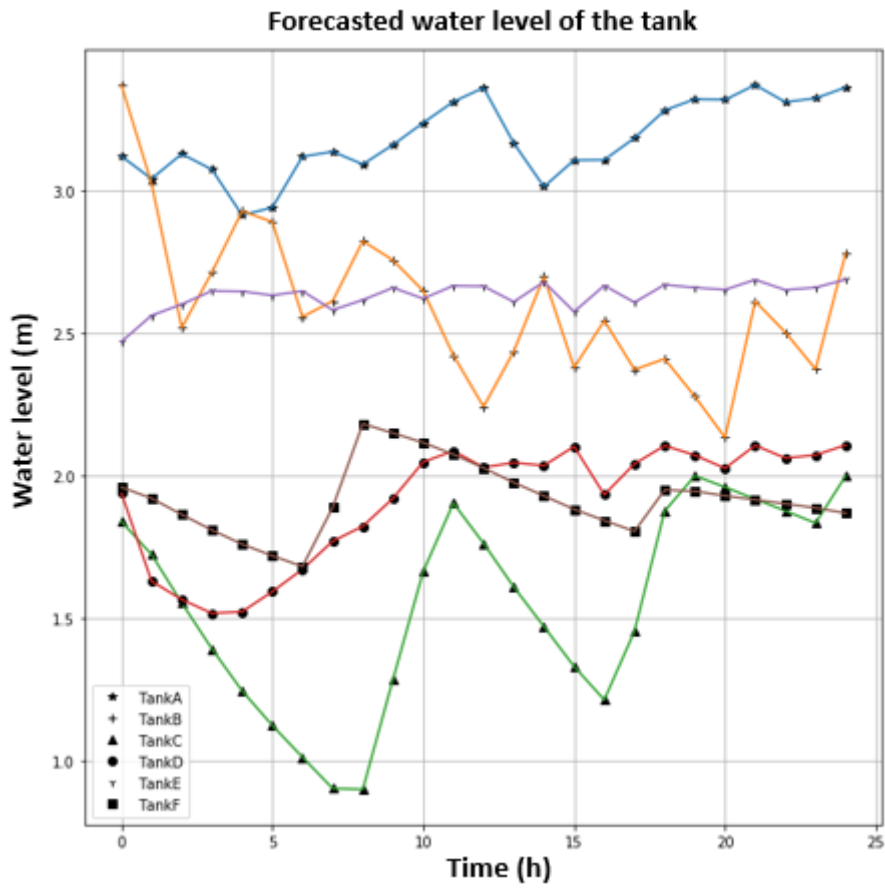
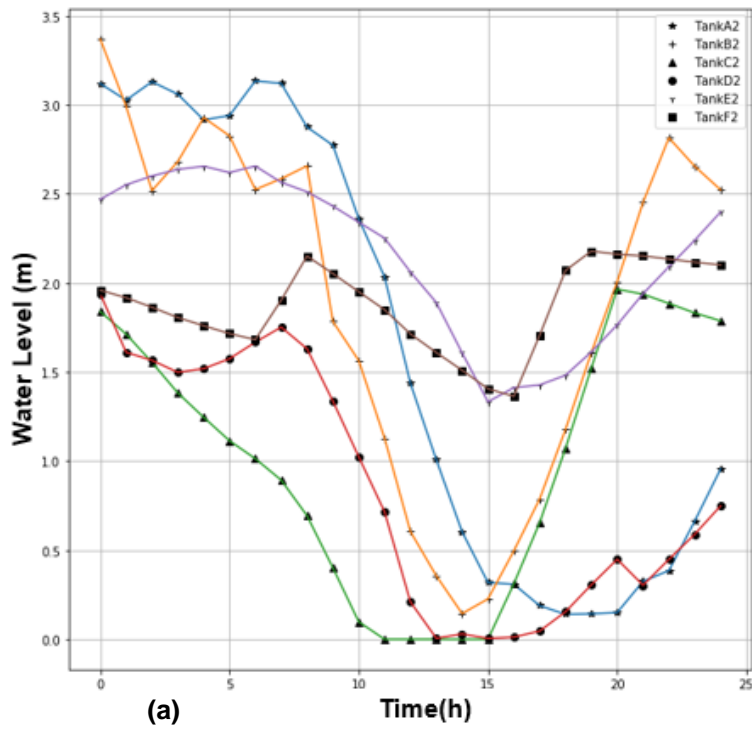

Fig. 33 – Forecasted water level of the tanks for the Richmond network.

### 1 – Reference Control



### 2 – Adaptive Control

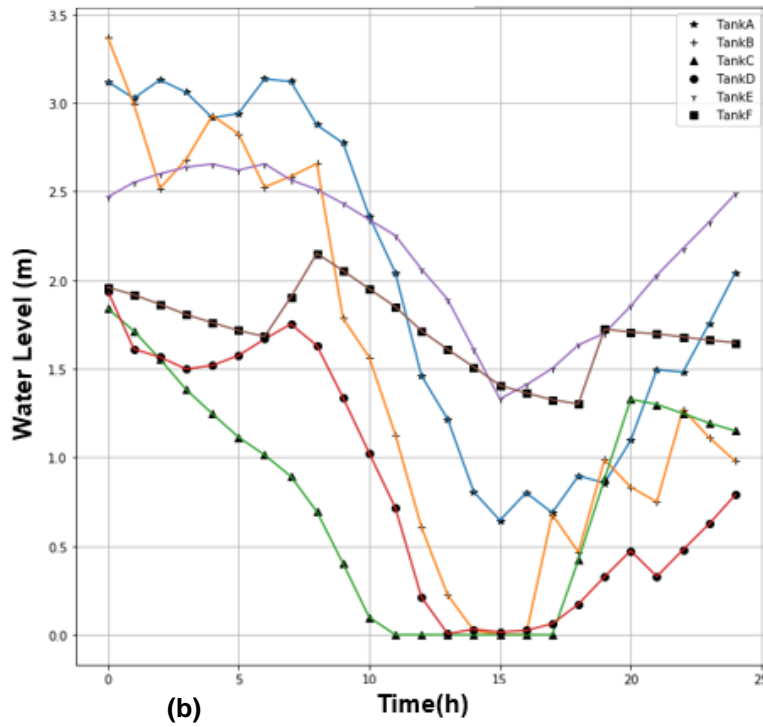
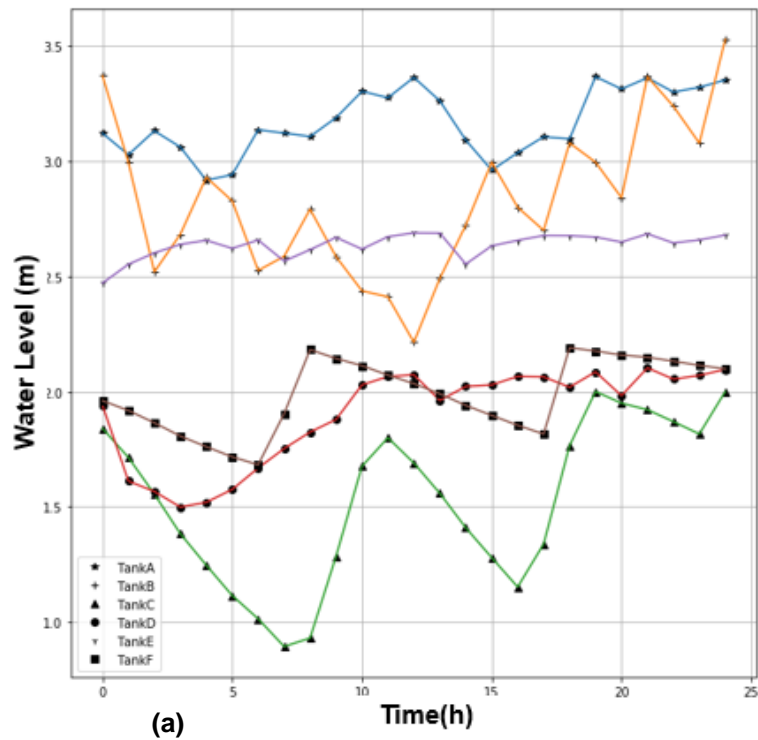

Fig. 34 – Results for fire situation test: (a) the water level of every tank of the Richmond network with the reference control strategy and, (b) with the adaptive control strategy.

### 1 – Reference Control



### 2 – Adaptive Control

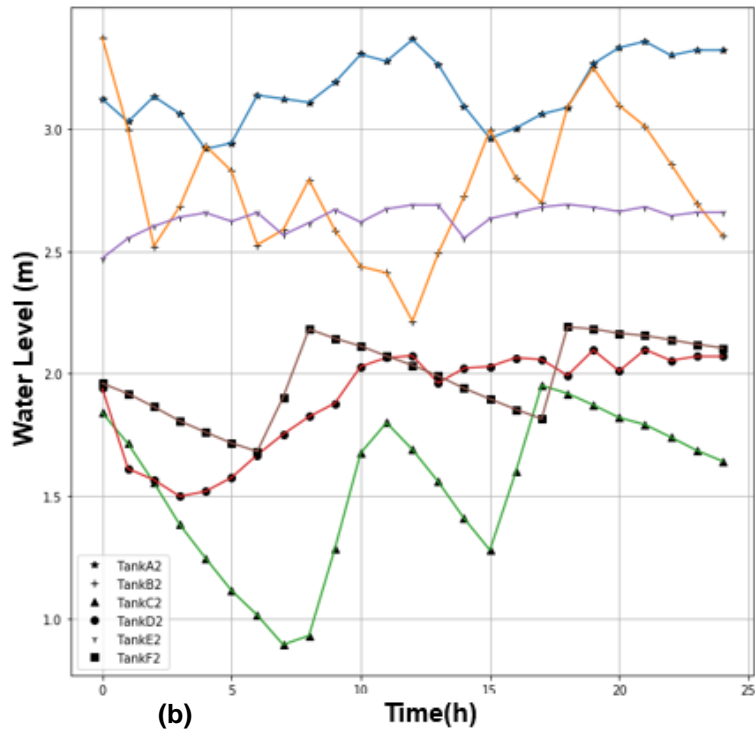
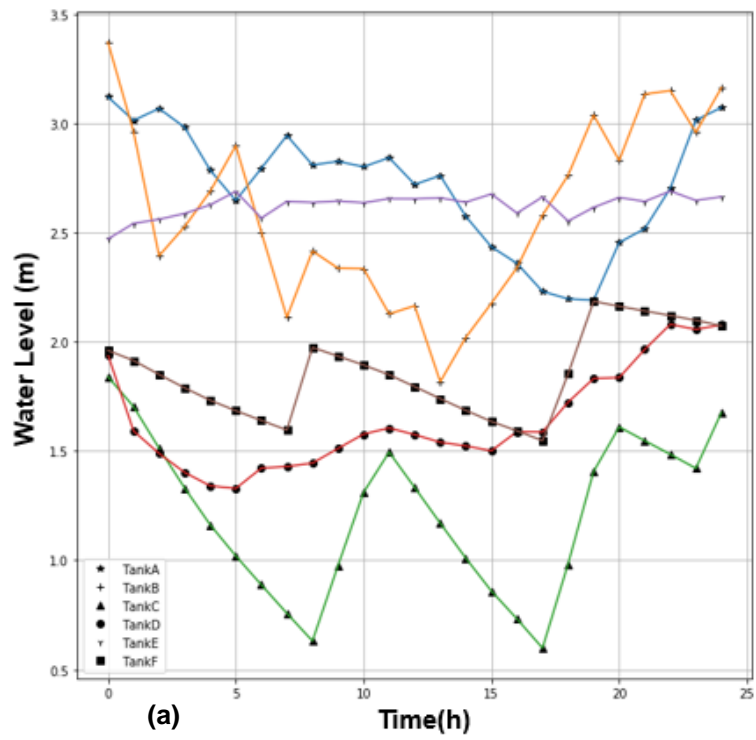

Fig. 35 – Results for average consumption with noise test: (a) the water level of every tank of the Richmond network with the reference control strategy and, (b) with the adaptive control strategy.



### 1 – Reference Control



### 2 – Adaptive Control

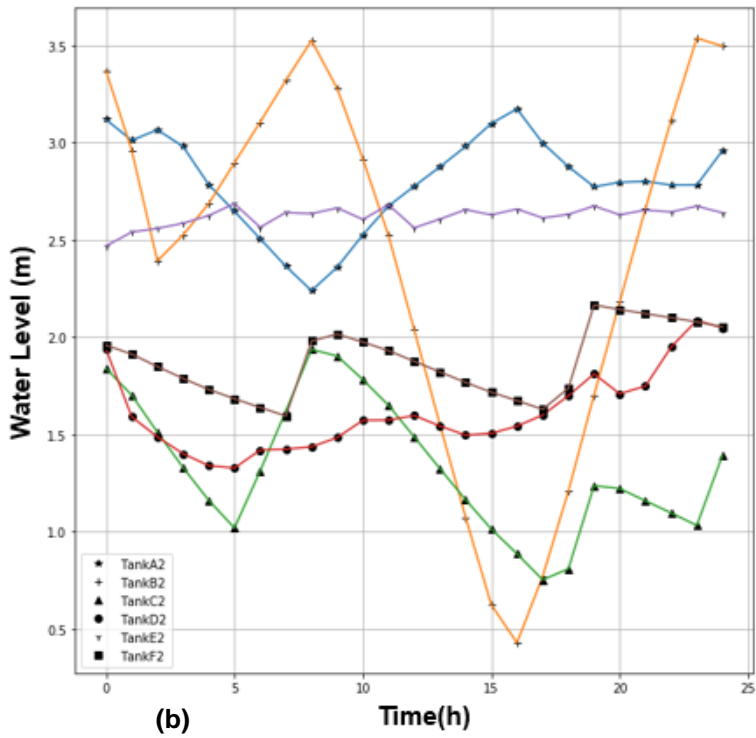
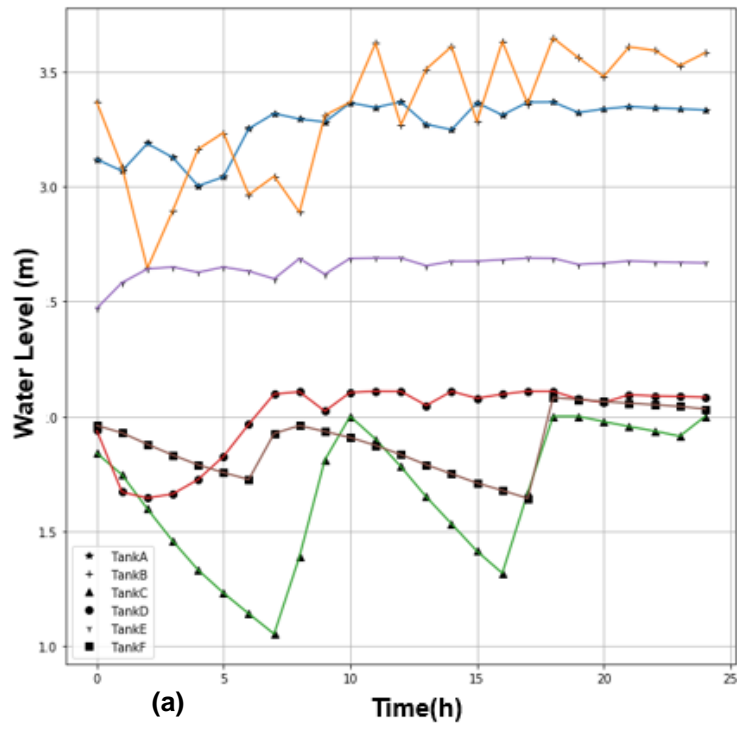

Fig. 36 – Results for overconsumption test: (a) the water level of every tank of the Richmond network with the reference control strategy and, (b) with the adaptive control strategy.

### 1 – Reference Control



### 2 – Adaptive Control

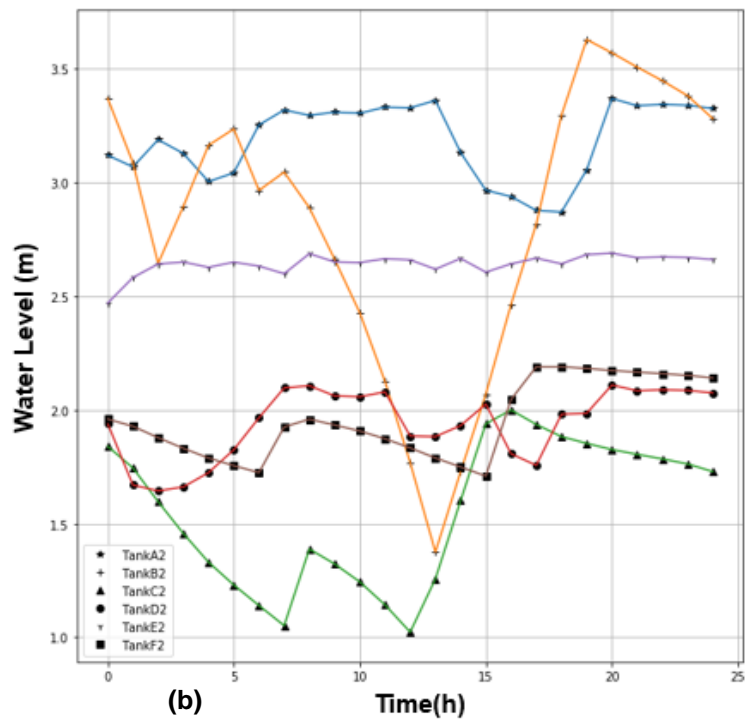

Fig. 37 – Results for underconsumption test: (a) the water level of every tank of the Richmond network with the reference control strategy and, (b) with the adaptive control strategy.

Table 5 – Cost of operation for all tests performed for each control method

TEST	COST REFERENCE CONTROL(\$)	COST ADAPTIVE CONTROL(\$)
1 – FIRE SITUATION	2993088.37	526226.63
2 – NOISE	14124.85	13779.36
3 – OVERCONSUMPTION	14092.54	15580.57
4- UNDERCONSUMPTION	15305.99	14115.01
REFERENCE (FORECAST)	15296.4	

The adaptive controller delivered good results in the Richmond network case study. It outperformed the reference controller in 3 out of the 4 tests. As it can be observed in test number 3, the adaptive controller didn't obtain better results than the optimal strategy. This might be a result of lack of statistical significance. Perhaps a collection of many simulations that emulated specific established patterns, as presented in the previous case study, would give different results and certainly strengthen the conclusions.

The fact that the initial reference isn't optimal introduced some ambiguity in the comparison of results. The simulation might create accidental or meaningless improvements due to the fact that the strategy is not optimized, perhaps the case of test number 3. In terms of scalability, this case-study clearly shows the efficacy of the methodology when applied in complex networks, indicating that the complexity of the network is not a limitation.

It's necessary to mention that the results might be less attractive if it's used a fully optimized initial pumping strategy as a reference, and this is perhaps the most significant limitation of this case study. Nevertheless, it showed the ability of the adaptive controller to search the most cost-efficient solutions by achieving lower costs in every situation when compared with the reference, to the exception of test number 3 which is equal.

Overall the adaptive controller was successfully implemented in the Richmond network; however, didn't deliver the results promised in the previous case-study. The simulation scenarios are very similar to the experienced in the real world, particularly the test number 2, which makes good evidence that the adaptive controller can be implemented in pumping stations and provide a cost-efficient automatic solution. In fact, it might even improve the cost when compared with the established reference.



## 4 Conclusion

---

This work started by stating that the aim is to develop a control methodology that surmounts the existing ones and that hopefully might become a cornerstone for the emerging water grids technology.

### 4.1 Final Remarks

To address the accomplishment of the objective, it's first necessary to clearly highlight the limitations and successes achieved during this project. After compiling the discussion for both case studies, it's possible to firmly arrive at a conclusion, with the promise that, this is in fact just the beginning. The beginning of the exploration of new and better methodologies to control the pumping stations and that hopefully can improve as a result of the investigations made in this project. For that, it's suggested some ideas for further exploration.

#### 4.1.1 Achievements

The most important remark to make in this work is to determine whether the methodology developed actually represents an improvement compared to the state-of-the-art solutions for control methods. The adaptive controller can, in fact, do a proactive search for the most cost-efficient adaptations to nullify the observed disturbance. The efficacy of this point seemed to be limited by the necessity to validate the constraints of this search which is reflected mainly in the first case-study. Nevertheless, the controller successful delivered an automatic and cost-efficient control of the pumping stations.

In both case studies, the adaptive controller reached similar cost-efficient results when compared with the optimal controller. Even if further investigations demonstrate that the cost-efficiency of the adaptive controller can't rival the combination of an operator and an optimal strategy controller, the fact that achieves this process without intervention makes it a more promising solution for emerging technologies.

If the controller is compared with the typical feedback controllers used in rudimental distribution systems, where the main purpose is to keep the water at a determined level, then the developed adaptive controller was extremely successful by delivering the same automatic results with a 2% to 40% lower cost of operation. Even when compared with the optimal controller the cost-efficient might be in fact improved since the simulations shown that the higher cost of the designed controller is accompanied by an increase in water in the tank.

#### **4.1.2 Limitations**

The designed controller in this work successfully achieved the objectives proposed. However, there is some refinement to be done to clarify some doubts and deliver a more robust solution.

There are some bottlenecks to be addressed in the simulations. For example, the first case study examined an ideal scenario, which is not often observed in real WDN. The second case study manages to replicate the conditions of a real-world WDN, but it's not very extensively explored. For further investigations, simulations that replicate as exactly as possible the scenario of a real WDN, would be ideal to test the performance of a designed controller. Perhaps using real data from real WDN would be the best option.

Besides that, the methodology can be further explored mathematically, and perhaps be combined with new and more robust ideas. For example, in the hierarchy idea the mathematical relations could be better developed to further express the idea. Also, it's necessary to refine a method to deal with relationships and tanks in complex networks, since the one developed in this work, although it's effective, it's a simplification, and perhaps can be improved to deliver better results.

#### **4.1.3 Final Notes**

The adaptive controller showed promising results when compared with the state-of-the-art solutions for control methodologies. The conclusions drawn from the simulations support its performance. Therefore, there is a very high promise of successful integration in future technologies if further development is made to tackle the mentioned limitations.

These pillars of innovation are in by itself a great success of this work. Although the objective achieved in this work are good, there is still margin for improvement. Hopefully, this work provokes food for thought for other researchers in the water industry that has the mathematical skill set and the drive to improve this work further and provide a reliable solution to market-technologies that aim at creating a "utopic water distribution system."

## 4.2 Future Work

*"If I have seen further it is by standing on the shoulders of Giants"*  
(Isaac Newton, 1675)

The main improvements to this work can be introduced by (i) improving the mathematical robustness of the methodology, (ii) create a better simulation framework, (iii) developed a more precise pumping tank relationship, perhaps by using finite elements method and, (iv) explore a holistic solution that it's not limited to cost-efficiency. Besides that, the application of the methodology in a real pumping control station with real data might be the best idea to prove the efficacy of the adaptive controller.

For further new investigations, it's suggested to research the applicability of deep reinforcement learning techniques for automatic control of the pumping stations.





## References

- [1] Mays, L. W. (2000). *Water distribution systems handbook*. McGraw-Hill.
- [2] Walski, T. M., Brill Jr, E. D., Gessler, J., Goulter, I. C., Jeppson, R. M., Lansey, K. & Ormsbee, L. (1987). Battle of the network models: Epilogue. *Journal of Water Resources Planning and Management*, 113(2), 191-203.
- [3] Wolf, J. L. (1987). Institutions: Alliance to Save Energy. *Environment: Science and Policy for Sustainable Development*, 29(3), 3-4.
- [4] Wasiuta, M. (2009). Worldometers; o.s.Earth; GENI. *Journal of the Society of Architectural Historians*. 68(4), 590-593.
- [5] Feldman, M. (2009, April). Aspects of energy efficiency in water supply systems. In *Proceedings of the 5th IWA Water Loss Reduction Specialist Conference, South Africa* (pp. 85-89).
- [6] Rao, Z., & Salomons, E. (2007). Development of a real-time, near-optimal control process for water-distribution networks. *Journal of Hydroinformatics*, 9(1), 25-37.
- [7] Swan-forum.com. (2019). About | SWAN. [online] Available at: <https://www.swan-forum.com/about/> [Accessed 19 May 2019].
- [8] Rqpotech.com. (2019). Smart Water Grid and Pump Station Monitoring | RQP Technology AB. [online] Available at: <http://www.rqpotech.com/smart-water-grid-and-pump-station-monitoring/> [Accessed 2 Jun. 2019].
- [9] da Costa Coelho, B. (2016). *Energy efficiency of water supply systems using optimisation techniques and micro-hydropumps*(Doctoral dissertation, Universidade de Aveiro (Portugal)).
- [10] Mouatadid, S., & Adamowski, J. (2017). Using extreme learning machines for short-term urban water demand forecasting. *Urban Water Journal*, 14(6), 630-638.
- [11] Coelho, B., & Andrade-Campos, A. (2014). Efficiency achievement in water supply systems—A review. *Renewable and Sustainable Energy Reviews*, 30, 59-84.
- [12] Evans, R., Li, L., Mareels, I., Okello, N., Pham, M., Qiu, W., & Saleem, S. K. (2012). Real-time optimal control of river basin networks. In *System Identification*,

Environmental Modelling, and Control System Design (pp. 403-421). Springer, London.

[13] Bakker, M., Vreeburg, J. H. G., Van Schagen, K. M., & Rietveld, L. C. (2013). A fully adaptive forecasting model for short-term drinking water demand. *Environmental Modelling & Software*, 48, 141-151.

[14] Sardinha-Lourenço, A., Andrade-Campos, A., Antunes, A., & Oliveira, M. S. (2018). Increased performance in the short-term water demand forecasting through the use of a parallel adaptive weighting strategy. *Journal of Hydrology*, 558, 392-404.

[15] Feliu-Battle, V., Rivas-Perez, R., & Castillo-García, F. J. (2013). Simple fractional order controller combined with a Smith predictor for temperature control in a steel slab reheating furnace. *International Journal of Control, Automation and Systems*, 11(3), 533-544.

[16] Belkacemi, M. E. I., Lachhab, A., Limouri, M., Dahhou, B., & Essais, A. (2001). Adaptive control of a water supply system. *Control Engineering Practice*, 9(3), 343-349.

[17] Ioannou, P. A., & Sun, J. (2012). *Robust adaptive control*. Courier Corporation.

[18] Wang, Z., Polycarpou, M. M., Uber, J. G., & Shang, F. (2005). Adaptive control of water quality in water distribution networks. *IEEE Transactions on Control Systems Technology*, 14(1), 149-156.

[19] Vrachimis, S. G., Eliades, D. G., & Polycarpou, M. M. (2014). Enhanced adaptive control of water quality in water distribution networks by incorporating abrupt hydraulic changes. *Procedia Engineering*, 89, 239-246.

[20] Wang, S., & Burnett, J. (2001). Online adaptive control for optimizing variable-speed pumps of indirect water-cooled chilling systems. *Applied Thermal Engineering*, 21(11), 1083-1103.

[21] Georges, G. (1994, August). Decentralized adaptive control for a water distribution system. In *Proceedings of the 3rd IEEE Conference on Control Applications* (Vol. 2, pp. 1411-1416).

[22] Pérez, R. R., Moraga, C. P., González, J. P., & Kovalenko, P. I. (2002). Robust adaptive predictive control of water distribution in irrigation canals. *IFAC Proceedings Volumes*, 35(1), 97-102.

- [23] Kang, D. (2014). Real-time optimal control of water distribution systems. *Procedia Engineering*, 70, 917-923.
- [24] SILVA, M., Araújo, C. S. D., Bezerra, S. D. T. M., Arnaud, S., Souto, C. D. R., & Gomes, H. P. (2015). Sistema de controle adaptativo aplicado a um sistema de distribuição de água com ênfase na eficiência energética. *Revista de Eng Sanit Ambient*, 20(3), 405-413.
- [25] Xu, C., & Goulter, I. C. (1999). Reliability-based optimal design of water distribution networks. *Journal of Water Resources Planning and Management*, 125(6), 352-362.
- [26] A. Andrade-Campos, J. Dias-de-Oliveira. (2018). Benchmark 2018: Operação eficiente de bombagem, Minimização dos custos de bombagem de uma estação elevatória. Universidade de Aveiro.