

Extrube

Desenhos técnicos

| REVISION HISTORY | | | |
|------------------|-------------|------|----------|
| REV | DESCRIPTION | DATE | APPROVED |
| | | | |

Base

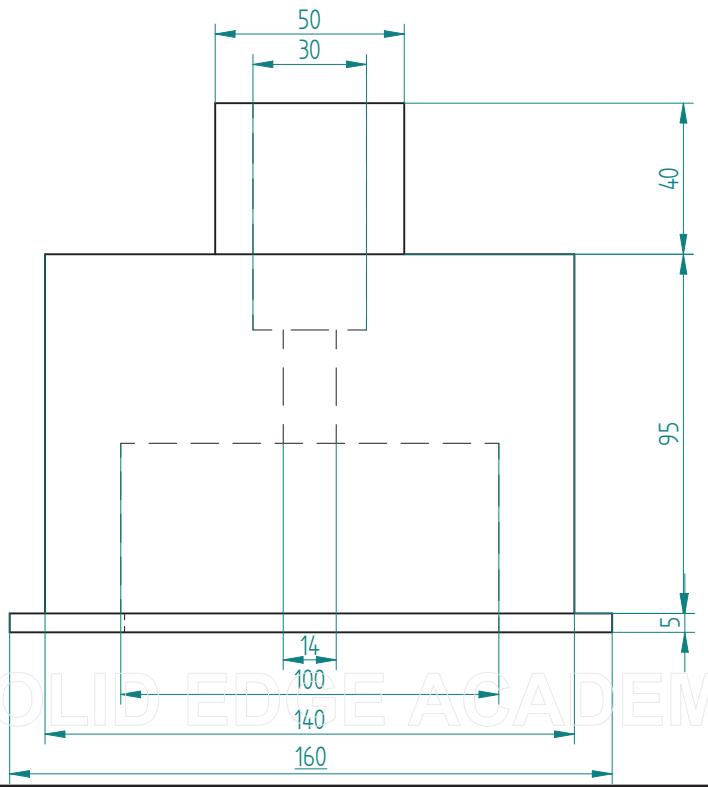
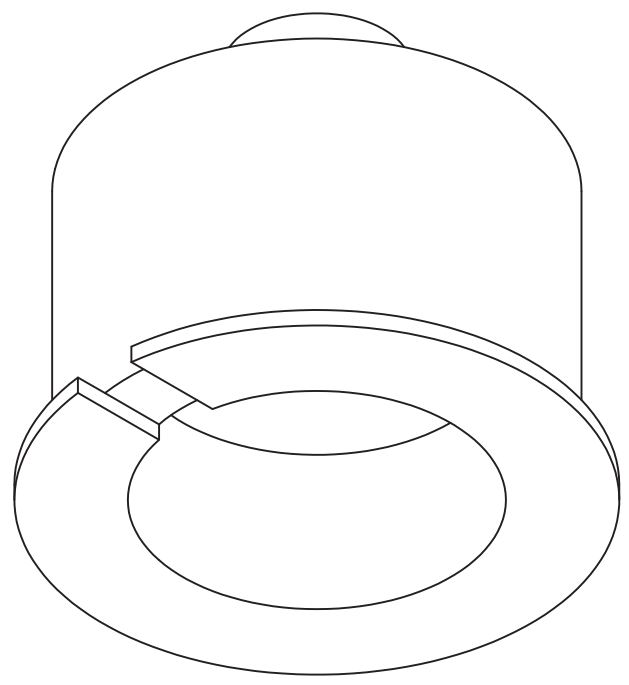
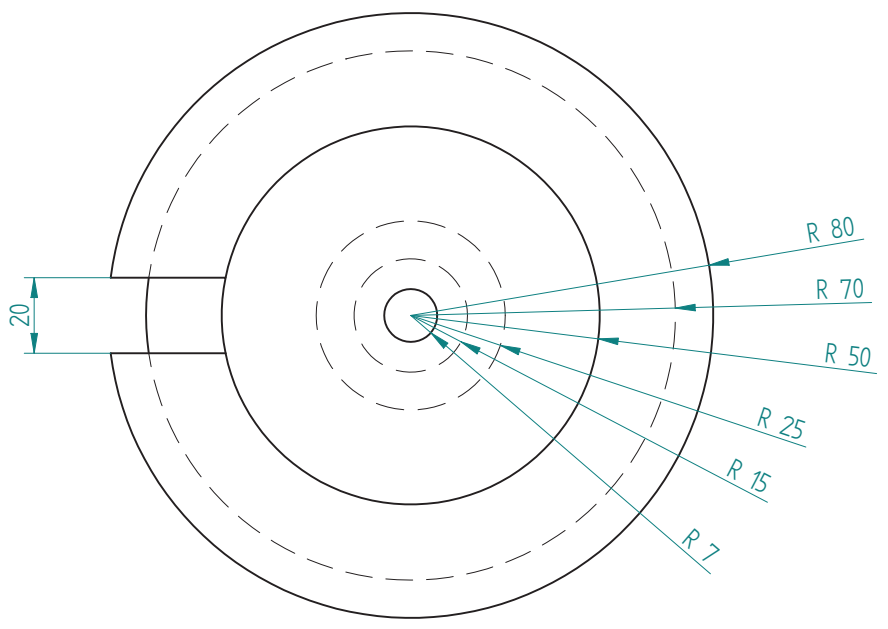

SOLID EDGE ACADEMIC COPY

| | | | |
|----------|------|----------|----------------|
| | NAME | DATE | Candeiro de Pé |
| DRAWN | joão | 11/26/17 | |
| CHECKED | | | |
| ENG APPR | | | |
| MGR APPR | | | |
| | | | SIZE |
| | | | AZ |

| REVISION HISTORY | | | |
|------------------|-------------|------|----------|
| REV | DESCRIPTION | DATE | APPROVED |
| | | | |

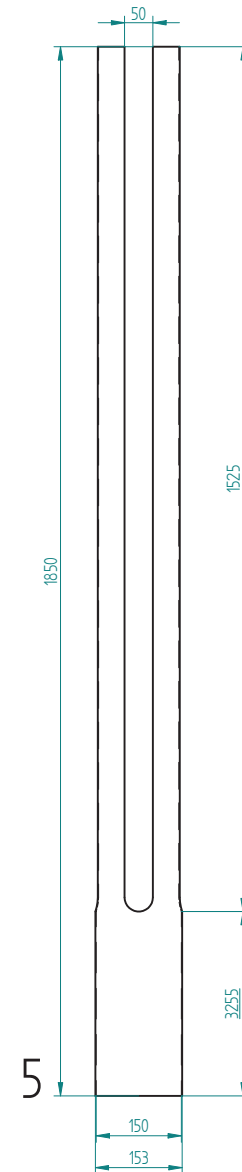
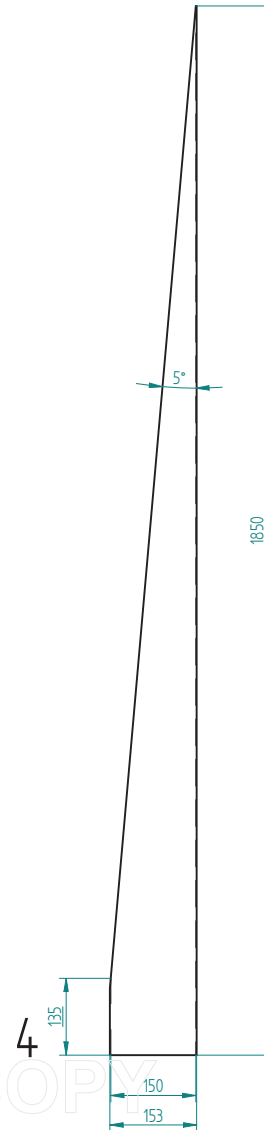
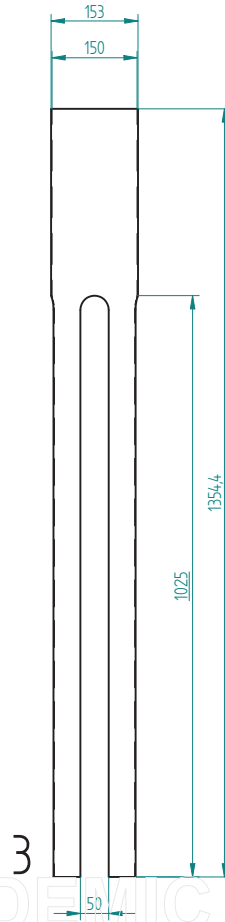
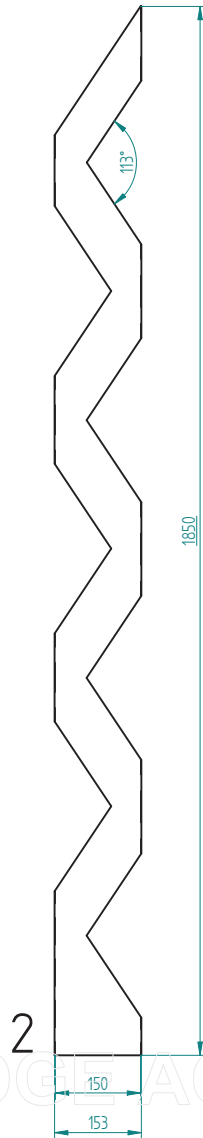
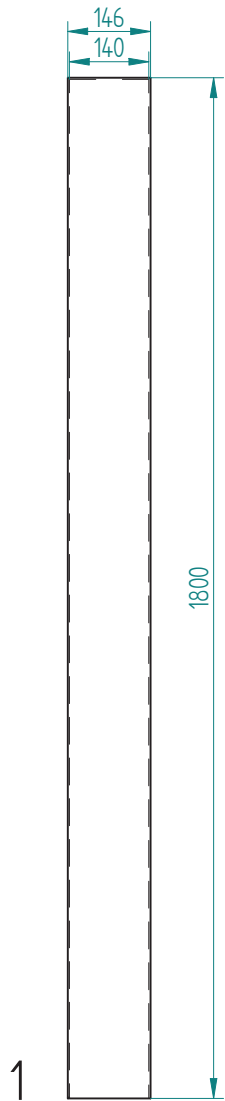
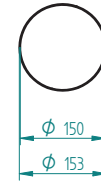
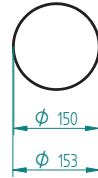
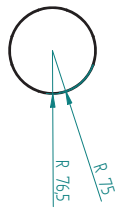
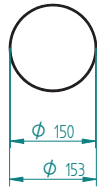
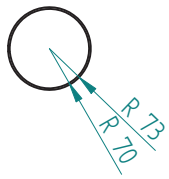

- 1- Tubo acrílico base
- 2- Componente 1
- 3- Componente 2
- 4- Componente 3
- 5- Componente 4

SOLID EDGE ACADEMIC COPY

| | | | |
|----------|-------|----------|----------------|
| DRAWN | NAME | DATE | Candeiro de Pé |
| CHECKED | joo o | 11/26/17 | |
| ENG APPR | | | |
| MGR APPR | | | |
| SIZE | | | A2 |

| REVISION HISTORY | | | |
|------------------|-------------|------|----------|
| REV | DESCRIPTION | DATE | APPROVED |
| | | | |

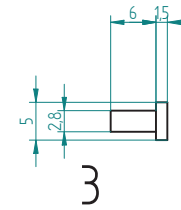
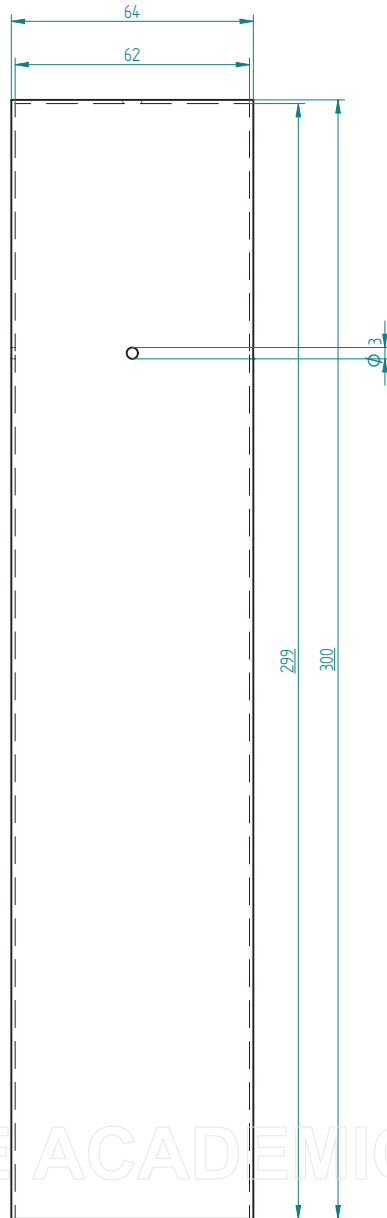
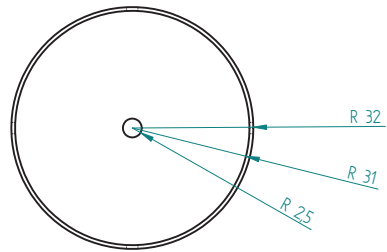

- 1 - Tubo acrílico
- 2- Suporte do casquilho
- 3- Parafuso

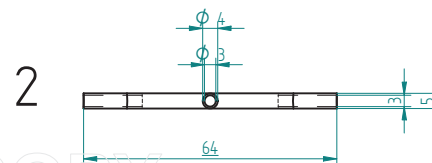
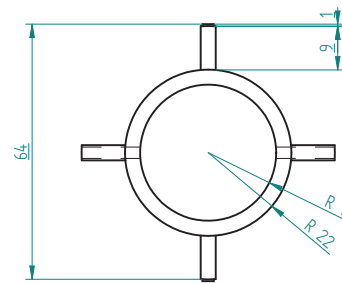

SOLID EDGE ACADEMIC COPY

| | | | |
|----------|------|----------|------------------------|
| DRAWN | NAME | DATE | Candeeiro de suspensão |
| CHECKED | joão | 11/29/17 | |
| ENG APPR | | | |
| MGR APPR | | | |
| | | | SIZE |
| | | | A2 |

| REVISION HISTORY | | | |
|------------------|-------------|------|----------|
| REV | DESCRIPTION | DATE | APPROVED |
| | | | |

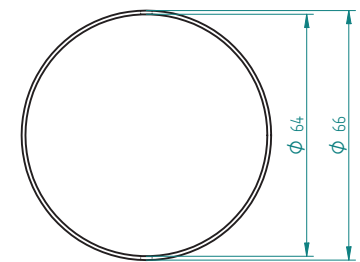
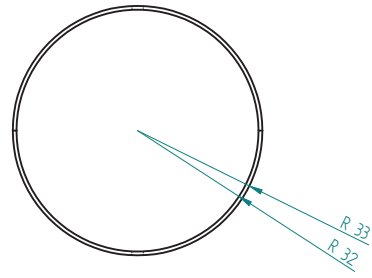
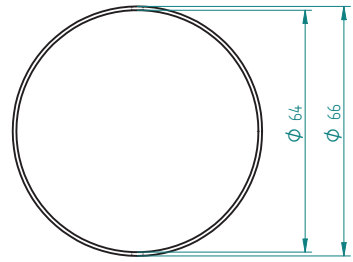
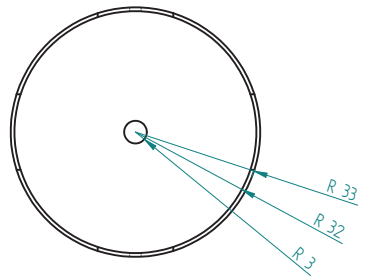

- 1- Componente 1
- 2- Componente 2
- 3- Componente 3
- 4- Componente 4

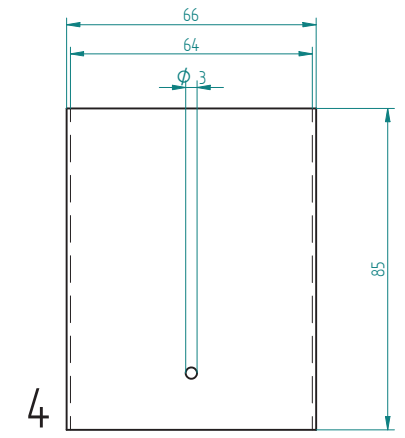
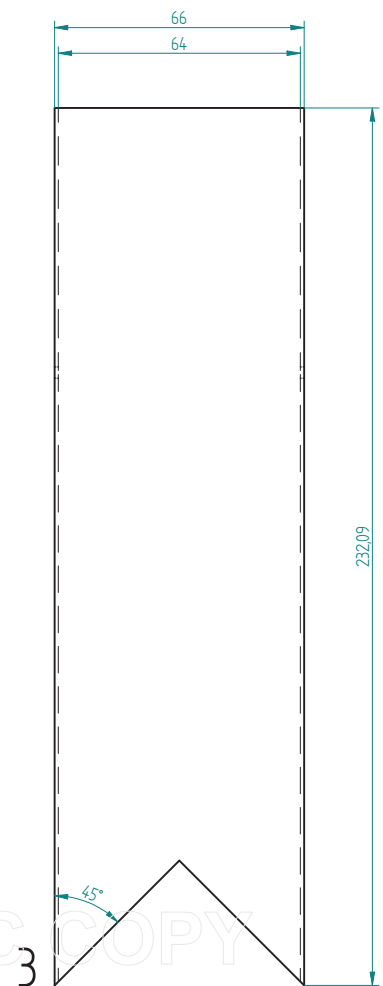
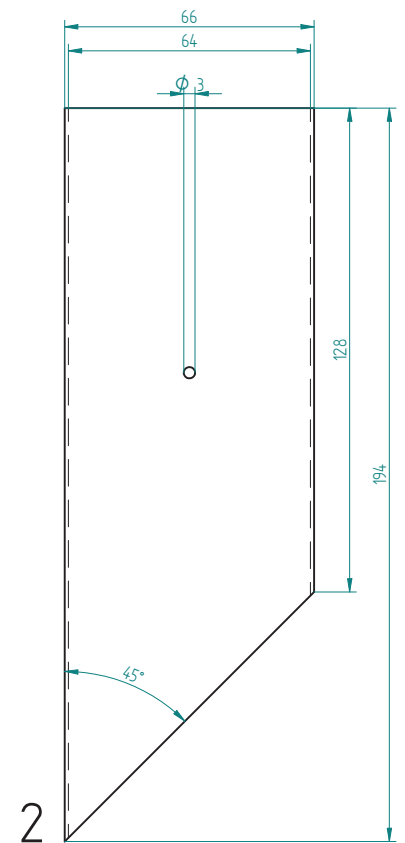
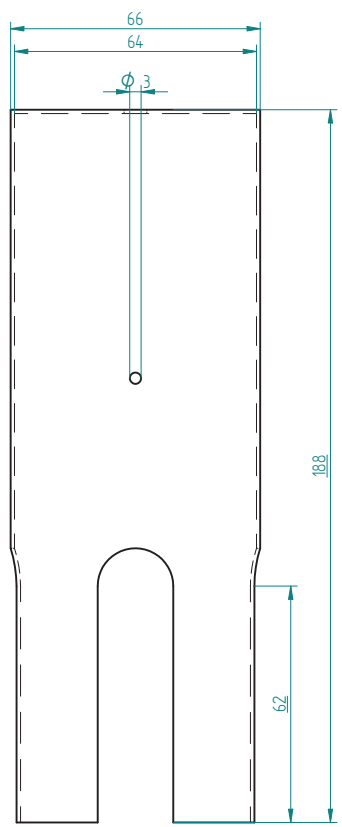

1

2

3

4

SOLID EDGE ACADEMIC COPY

| | | | |
|----------|------|----------|------------------------|
| | NAME | DATE | Candeeiro de suspensão |
| DRAWN | joão | 11/29/17 | |
| CHECKED | | | |
| ENG APPR | | | |
| MGR APPR | | | |
| | | | SIZE A2 |

REVISION HISTORY

| REV | DESCRIPTION | DATE | APPROVED |
|-----|-------------|------|----------|
| | | | |

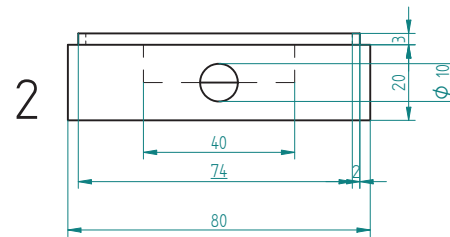
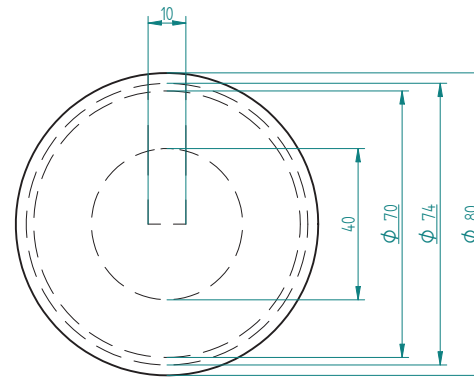
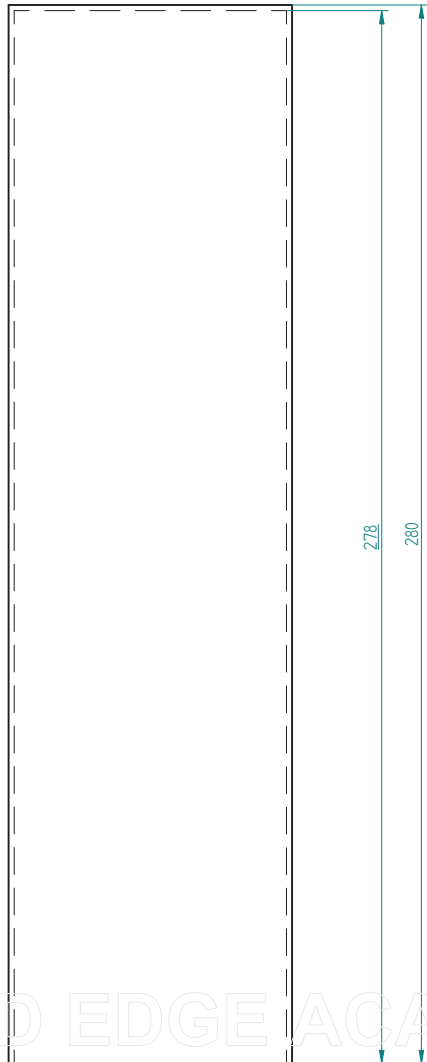
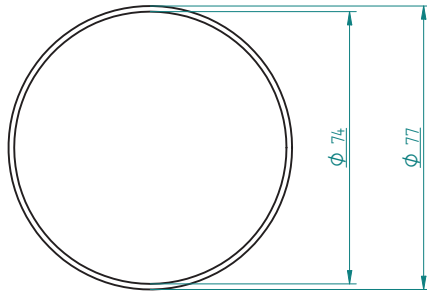

- 1- Cilindro acrílico
- 2- Base

SOLID EDGE ACADEMIC COPY

| DRAWN | NAME | DATE | Candeiro de mesa |
|----------|------|----------|------------------|
| | joão | 12/02/17 | |
| CHECKED | | | |
| ENG APPR | | | |
| MGR APPR | | | |

REVISION HISTORY

| REV | DESCRIPTION | DATE | APPROVED |
|-----|-------------|------|----------|
| | | | |

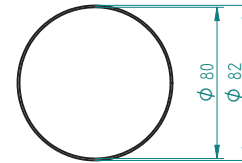
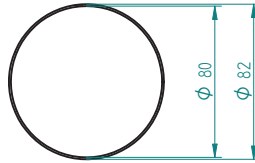
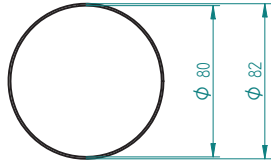
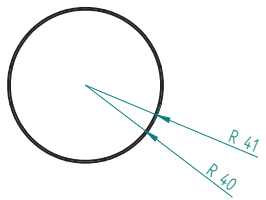

- 1- Componente 1
- 2- Componente 2
- 3- Componente 3
- 4- Componente 4

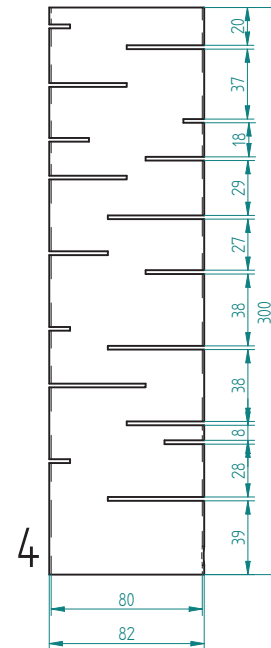
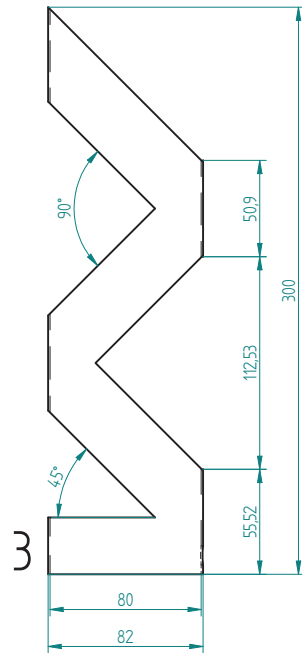
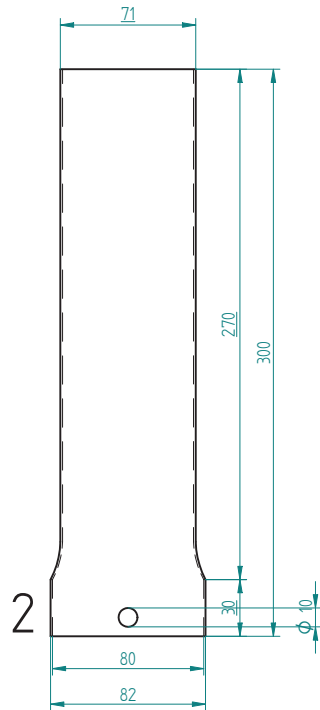
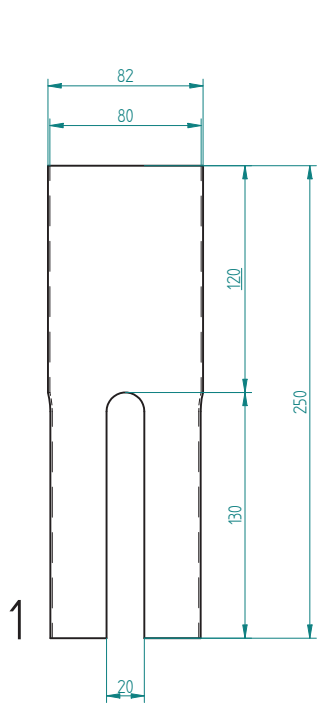

SOLID EDGE ACADEMIC COPY

| DRAWN | NAME | DATE | Candeiro de mesa |
|----------|-------|----------|------------------|
| CHECKED | jod o | 12/02/17 | |
| ENG APPR | | | |
| MGR APPR | | | |

| REV | DESCRIPTION | DATE | APPROVED |
|-----|-------------|------|----------|
| | | | |

- 1- Tubo Acrílico
- 2- Fixador
- 3- Base
- 4- Borracha
- 5- Porca
- 6- Suporte de casquilhos
- 7- Braço

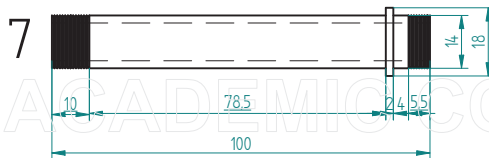
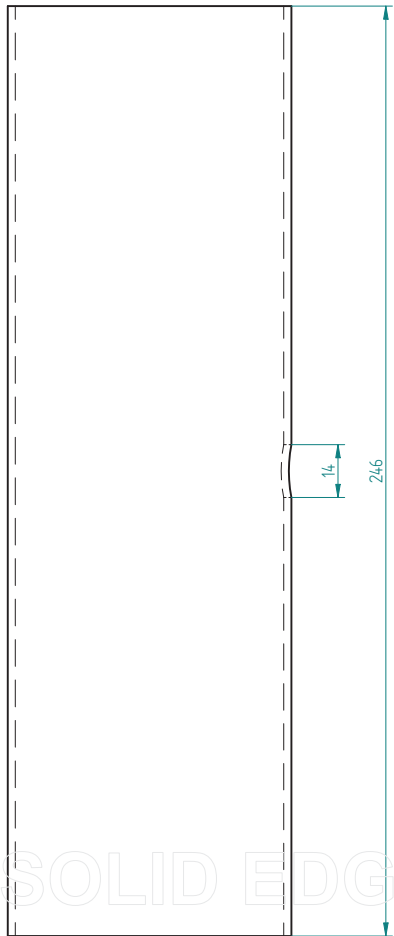
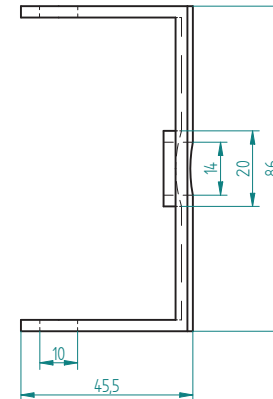
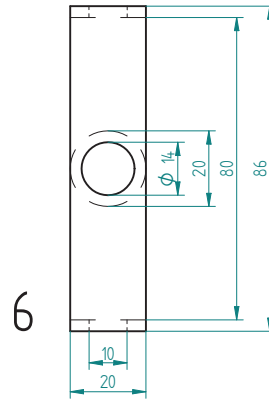
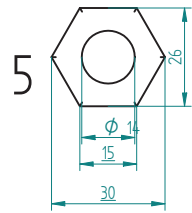
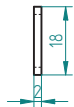
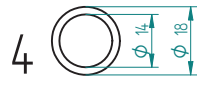
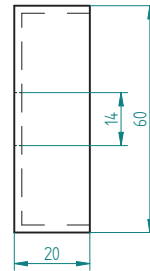
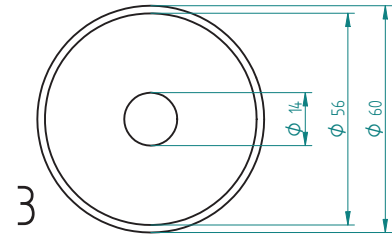
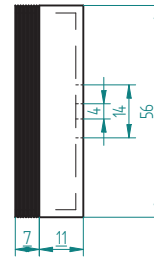
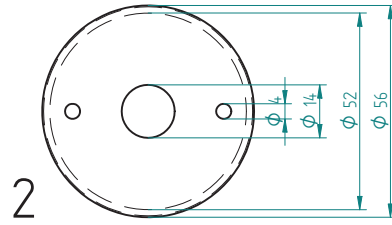
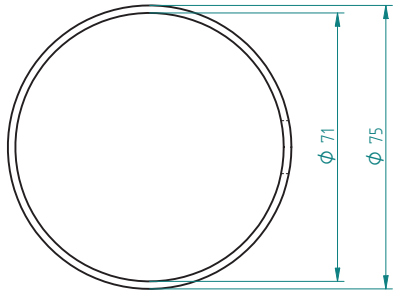

SOLID EDGE ACADEMIC COPY

| DRAWN | NAME | DATE | Aplique de parede |
|----------|------|----------|-------------------|
| joão | | 12/03/17 | |
| CHECKED | | | |
| ENG APPR | | | |
| MGR APPR | | | |

REVISION HISTORY

| REV | DESCRIPTION | DATE | APPROVED |
|-----|-------------|------|----------|
| | | | |

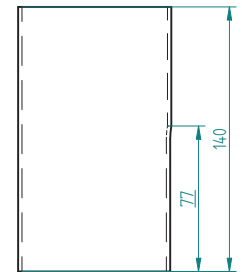
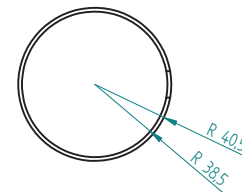
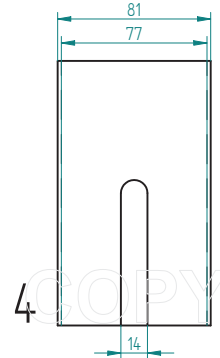
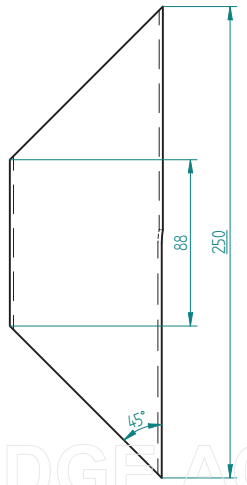
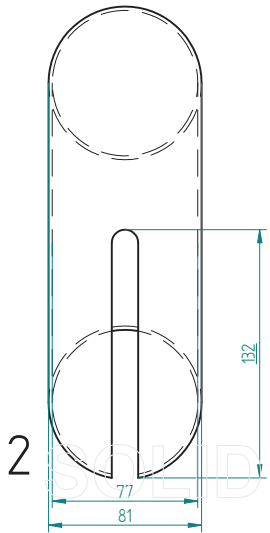
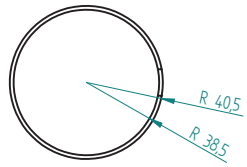
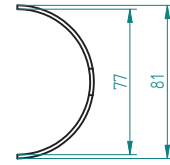
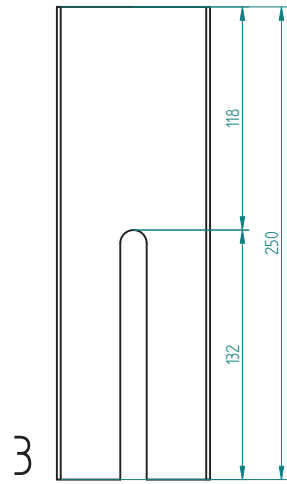
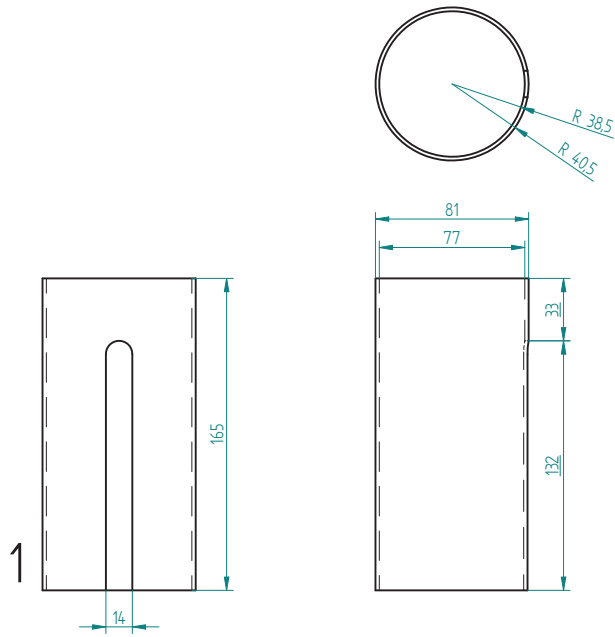

- 1- Componente 1
- 2- Componente 2
- 3- Componente 3
- 4- Componente 4

| DRAWN | NAME | DATE | Aplicue de parede |
|----------|-------|----------|-------------------|
| CHECKED | jod.o | 12/03/17 | |
| ENG APPR | | | |
| MGR APPR | | | |

SOLID EDGE ACADEMIC COPY